



Steps for assembly of a Bukobot. (Beta version 4, Feb 27, 2014).

Thanks to all for their comments – and patience – as our team works to bring you both better machines and better documentation.

Table of Contents

Definitions and introduction.	2
Tools and skills you will need.	3
Main Bukobot Frame.	3
Azteeg (Main electronics, aka Controller) Board Mount	9
X End assembly.	10
Assemble X and Y bearing rod assemblies.	14
Z rods	15
Attach wooden platform.	20
Attach heated platform (and cardboard)	21
Assemble the X carriage.	22
Assemble the extruder(s).	23
Cable management.	31
Place end stops.	32
Wiring up the controller.	33
Attach the power supply.	38
Attach glass sheet and platform tape	41
Filament management	41

Definitions and introduction.

The parts are collected into **kits** (labeled plastic bags.) Where possible, we will walk you through all the parts in a kit and highlight the **kit name** (which should be written on the bag) in yellow. In some cases we will have you use a few parts from different kits- we will point out where you open a kit for the first time.

The **X axis** runs along the bottom of the square frame you build initially.

The **Y axis** is the bar that runs underneath the platform (Y direction movement is done by the platform).

The **Z axis** is the vertical axis.

The "**front**" of the Bukobot is defined here as the end of the Y axis farther from the Azteeg board mount. (Or to put it another way, the Azteeg and other electronics will be in the back, and the power supply will be in the front. (See image below of assembled Bukobots – refer back to this if you get lost.) When we say "**left**" or right we mean from the point of view of an observer looking at the machine from the front – the spool of filament is on the right side of the machine shown with this definition.

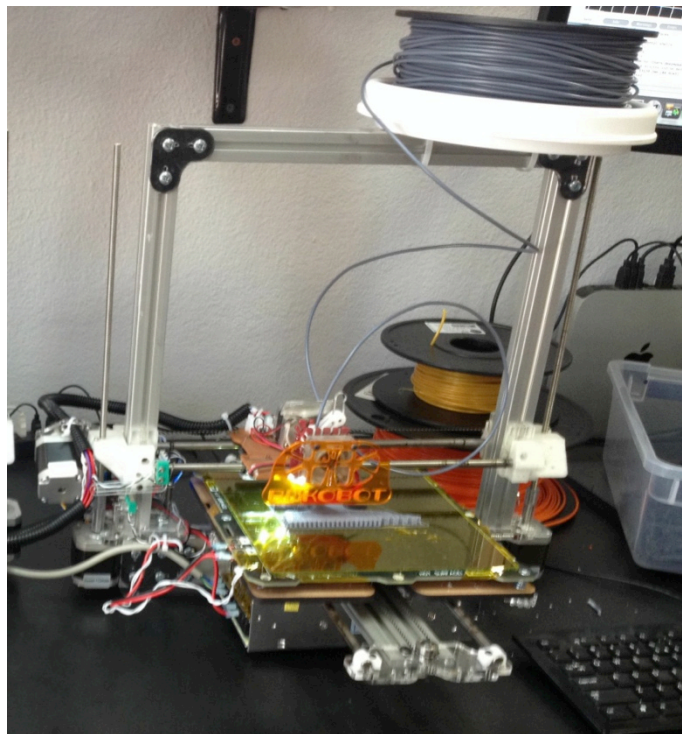
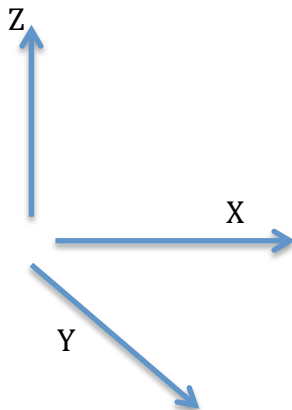

NOTE: THE MACHINE-IN-PROGRESS SHOULD NEVER BE PLUGGED INTO ANY POWER SOURCE OR YOUR COMPUTER.

Tools and skills you will need.

You will need a set of metric Allen wrenches, ranging in size from 1.5mm to 3 mm. You will also need a sturdy Phillips-head screwdriver for the frame; a 2.5 mm flathead screwdriver for the connector blocks; and a 1.5 phillips head for tightening the tiny screws on the pulleys.

You will need to be able to strip wires and to crimp some connectors; in a pinch scissors can be used to strip wire and pliers to crimp. If you are not familiar with stripping wires and crimping connectors, look at *instructables.com* or your favorite Maker site. No soldering is required.

The main skill you will need is patience and staying organized. Take your time, and be careful not to lose parts!

Main Bukobot Frame.

First, assemble the U-shaped lower part of the main frame of the Bukobot using the four corner pieces.

Open the **Frame Brackets Kit** (connectors that will connect the main aluminum beams).

The bottom aluminum piece is the wider piece that is tracked on all four sides.

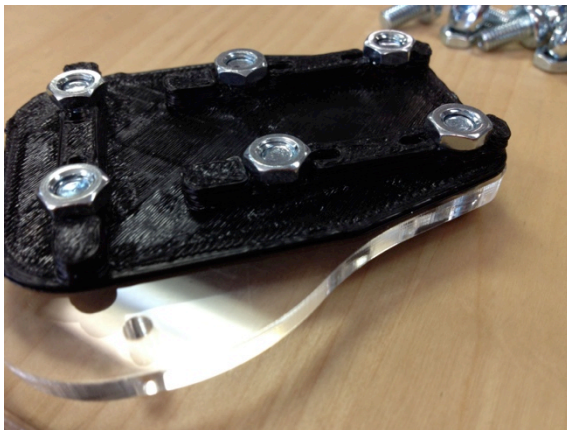

Lay out the four bottom feet/corner clear brackets(see picture below) thinking ahead about the through the orientation of all four. (Unfortunately it is easy to flip the acrylic.) Take the clear acrylic piece and the black plastic piece, and put the M5 screws on the outside of each piece, screwing through the black plastic.

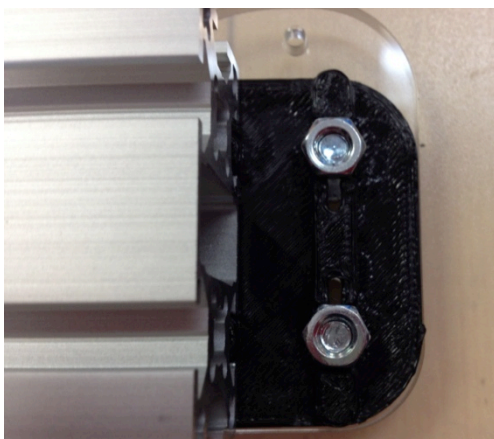

Put the nuts loosely on each screw and slide the first four nuts of each piece into the tracks of the aluminum bar that will be the bottom of the Bukobot. Repeat for the four brackets. Protruding acrylic feet should point down (away from the single-slotted part of the bottom frame.)

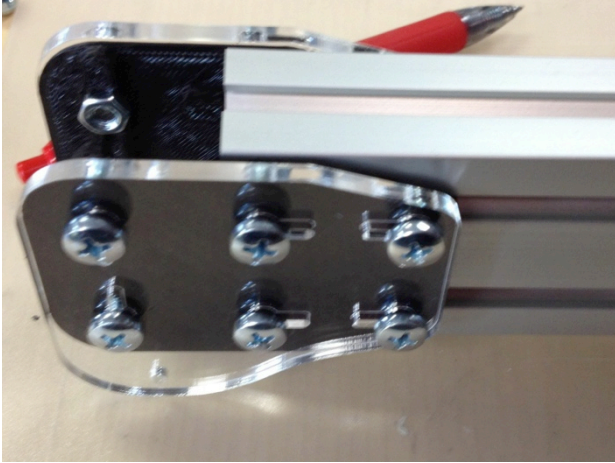

Then, attach ONLY the FIRST side beam. You can use what will be the top as a stop to guide how far down to push it. The bottom of the center aluminum rails should be flush with the bottom of the side rails.

Attach the T-nuts to the Y center beam. The screw heads and washer should be on the top (grooved) side. The T-nuts should be on the bottom. The T-nuts will just catch on the first thread or so. Slide the Y beam onto the bottom beam. The inside of the side beam should be 13.5 cm from the side of the Y beam to center it. Tighten it down.



Tighten down the first side before putting the second side on.



If any nut fails to catch hold it with a small screwdriver or allen key. (If it falls off completely you will need to start over with that piece- be sure to back off the screw tension such that the slack is inside, where you need it, not outside.)

Attach the second side rail to complete the bottom of the frame.

Attach the two connectors to the top beam but set it aside for now (do not attach to the sides.) We will attach that much later.

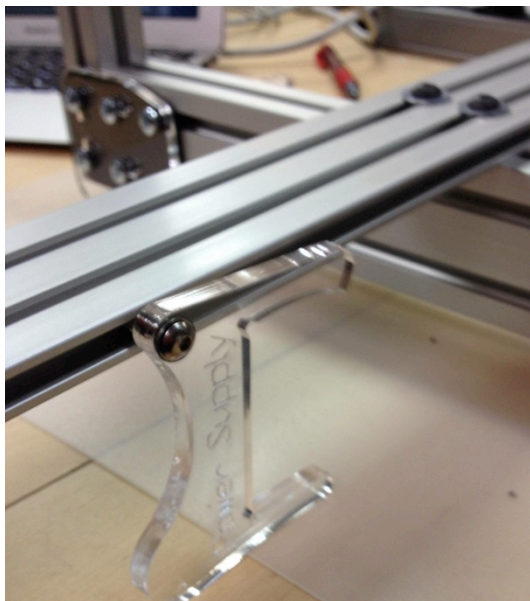
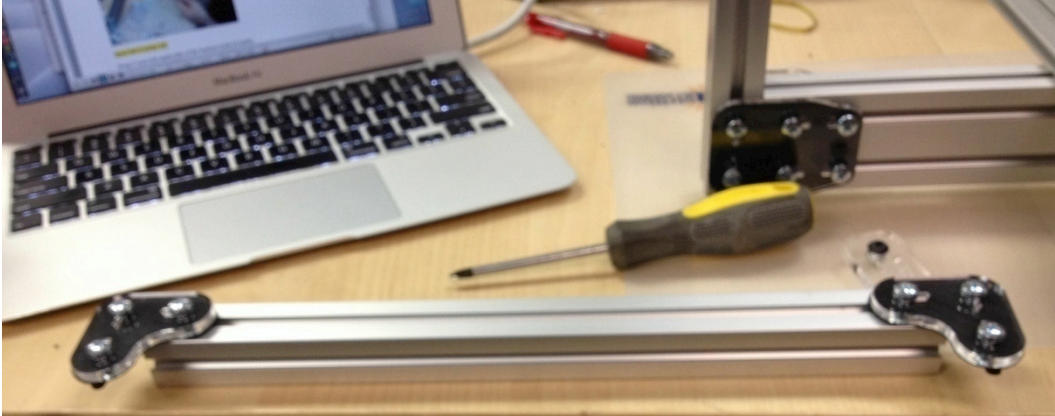

Attach the big "Power Supply" mount to the Y center beam. You will adjust it at the very end of the process, but just attach it for now and we will move it.

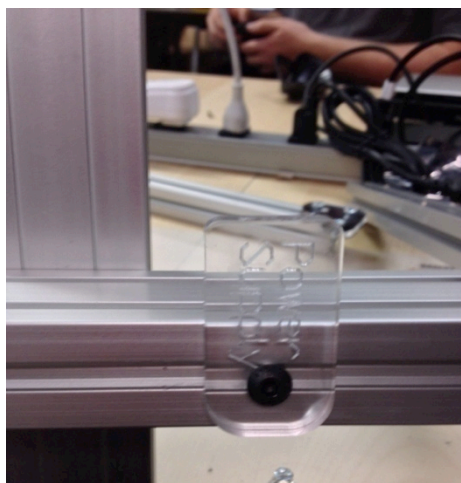

Drop a nut into the track on the very bottom of the Bukobot and attach the smaller "power supply" tab on the left side, sticking out forward. It is a little fiddly to get the nut in (you will have to wiggle it around to get it into the slot and flat). It is also a little hard to get it to catch- you may need to hold the nut in the track with another screwdriver again. You will adjust this significantly at the very end of the build- we are just putting it in a safe place for now.

Open the Y ends kit.

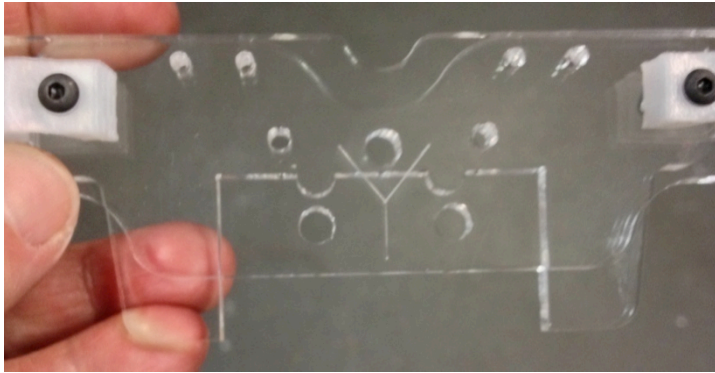

Assemble the Y ends (acrylic, says "Y" on the part) together with the white clips and M3 29 mm screws and nuts. Repeat for the second assembly.

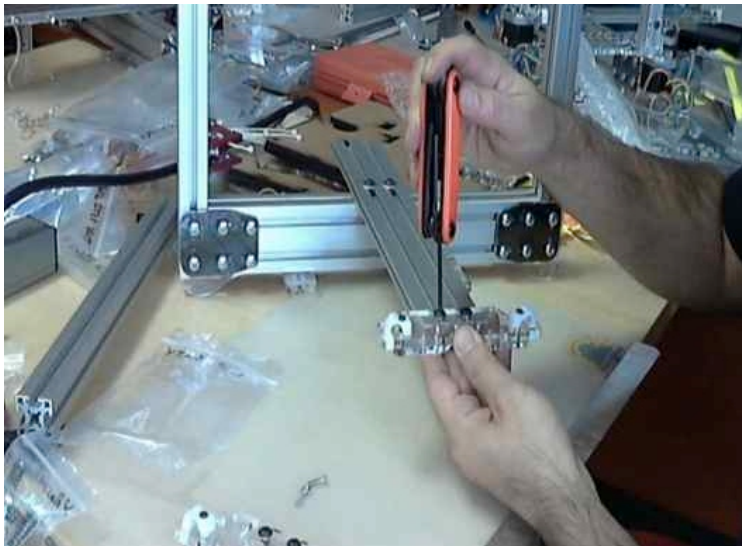

Attach the assembled ends to either side of the Y center beam. You have two screws left over that will be used later to attach the motor. Set them aside. You can put the small delrin (white) nuts on the ends now, but you will probably have to take at least one on each end off later on to put on the Y rods. For safekeeping put them on loosely now.

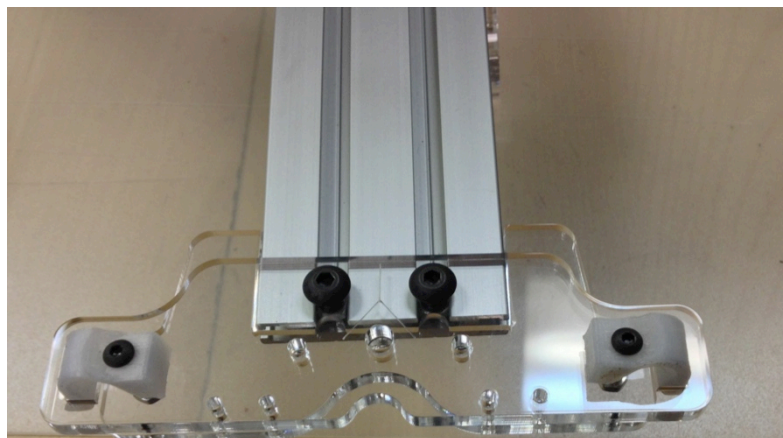

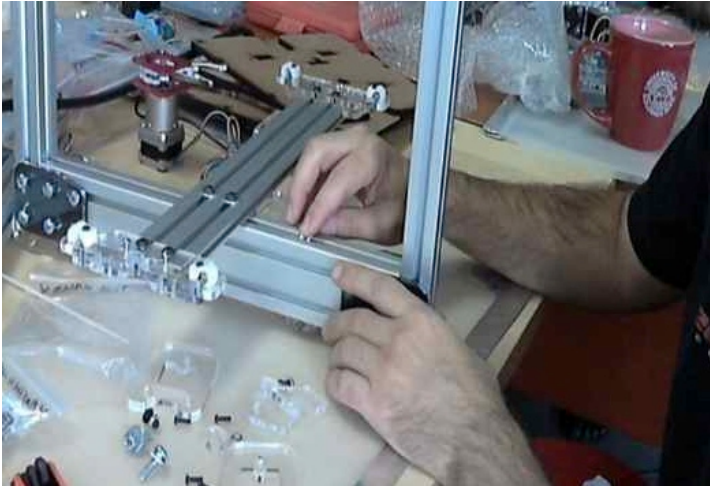

Open the Z motor kit.

Drop 1 nut into each side of the bottom track (2 total).

Now look at the clear acrylic pieces in this kit. There are three kinds of acrylic pieces in the kit. Take the two largest – these are the Z motor mounts, with one on each side. Each one says Z on the piece.

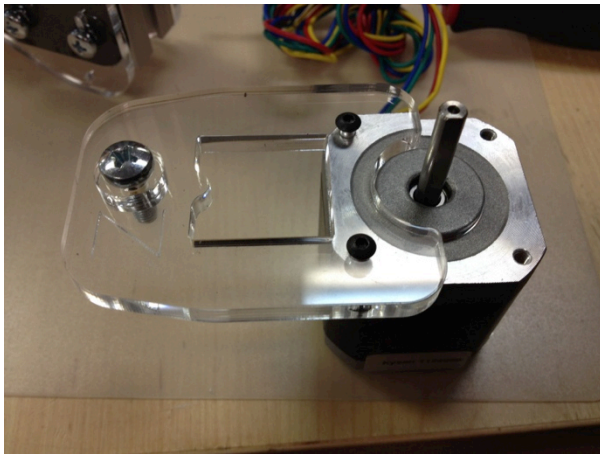

Attach a motor motor to each one as shown (this is the right-hand motor). Then slide them down the Z (vertical) rails on each side with the motors on the outside. They will slide down the Z (vertical) rails on each side. The wires should be in the “back” of the Bukobot. The longer part of the Y carriage is the front, and “right” means “right from the perspective of someone at the front.”



Attach the horizontal portion to the bottom track with a screw, then a washer, and then the acrylic spacer on the inside of the Z bar.

There is only one spacer, for the right side- the other side will have the Azteeg (main electronics) board mount occupying the equivalent space. But there should be a washer on both sides.

Attach the vertical portion (smaller acrylic piece) on the outside of the “U” of the frame (see image). Push it down firmly against the horizontal motor mount. Note that the pointed part of the vertical piece should point toward the back of the machine for the one on the right side and toward the front of the machine for the one on the left (motor mount) side

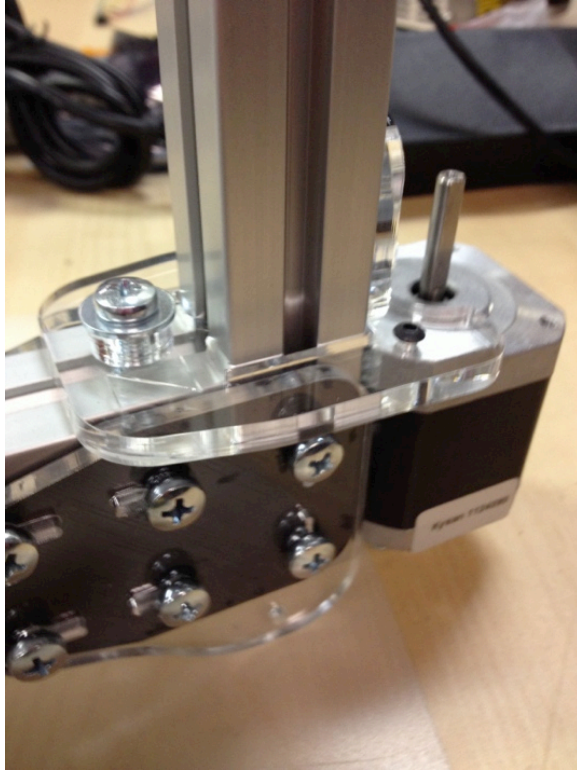

Another view of the assembled right hand side (as seen from the front.) Be sure that the motors are tight against the side of the frame and that there is no play anywhere in this assembly.

Push motor against the Z vertical frame and tighten the inner screw.

Azteeg (Main electronics, aka Controller) Board Mount

Open the **Controller Mount** kit. Now we will assemble the left-hand side Z axis motor area. In due course, the main electronics board (which we call the “controller” or “Azteeg board”



or “main electronics board” depending on context.) Slide the left-hand Z motor down the Z axis if you have not done so already. Then, attach the Azteeg (main electronics) board mount to the horizontal Z support on the left hand side with the screw on the inside of the Z axis and tighten while holding the motor against the frame to be sure that it is square and tight. The controller mount will push against the acrylic pieces we just put on tightly.

Attach the vertical acrylic piece. The point of this vertical piece should point toward the front of the machine and should be on the left side of the machine (as seen from the front.) The controller will be on the back left of the machine (out of the way.)

There is no acrylic spacer on this side, since the Azteeg board mount is the correct thickness without it. (A washer is needed for correct spacing though.) Some tweaking may be needed to get all the holes to line up to screw in the big screw on the inboard side of the frame (away from the motor.) Keeping the other screws a bit loose until that one is tight should help.

The wires on the Z motor should be facing toward the back for cable management. The end stop holders (vertical acrylic pieces on the z axis) need to be square so that the end stops can be put on later with adequate clearance.

There are several small C-shaped pieces of acrylic for later cable management in this kit. Set them aside for now.

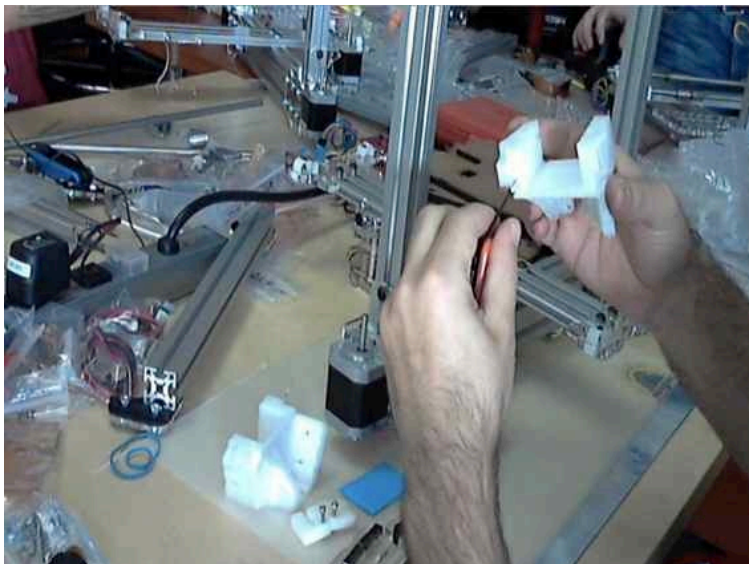

X End assembly.

Open the **X end kits.**

Pick up one of the X ends (white 3D printed part).

Put in the one screw that is different from the others in the kit (M3x12mm) into one of the white 3D printed pieces as shown (this screw is the z end stop trigger). You may need to ream out the hole for it first with an appropriately sized screwdriver. Don't get too carried away though or the screw may not be able to grab on. We will call this the LEFT side from here on out.

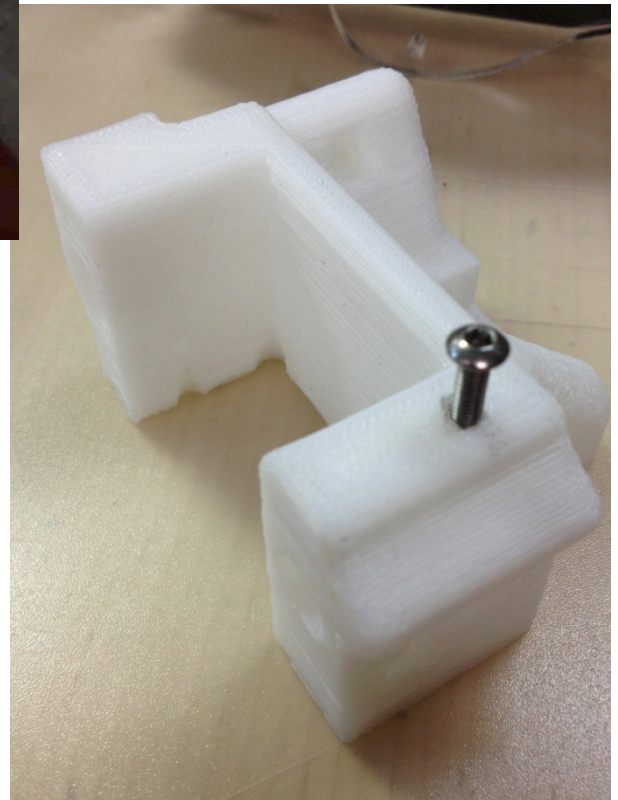

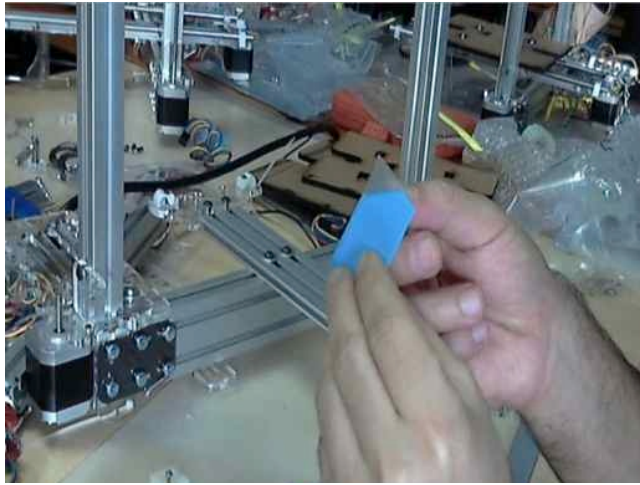

Take the blue backing off one piece of the UHMW tape.

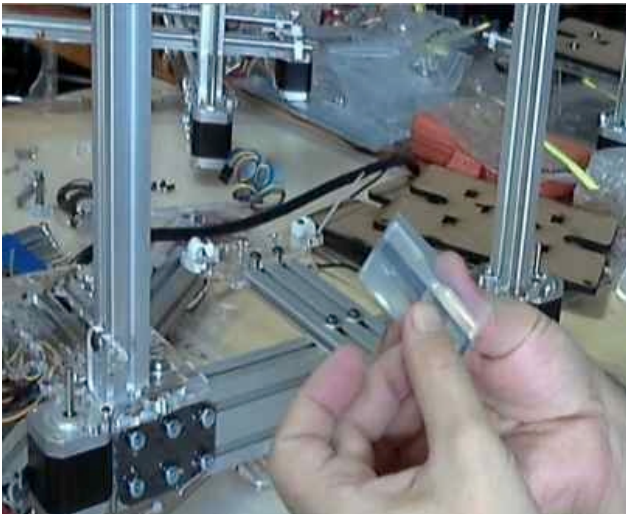

Take the rail slider and center the tape on the protruding central rail, which will fit into the slide.

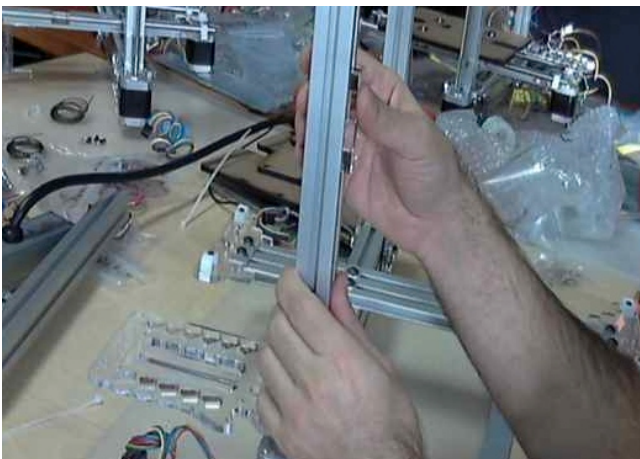

Push it into the slot to form the tape around the slider rail. Be sure that the tape is on tightly enough so that the tape makes nice right angles where it covers the protrusions.

Remove the piece from the rail and set it aside. Repeat for the four sliders and four pieces of tape.

Open the **X End Motor Mount kit**.

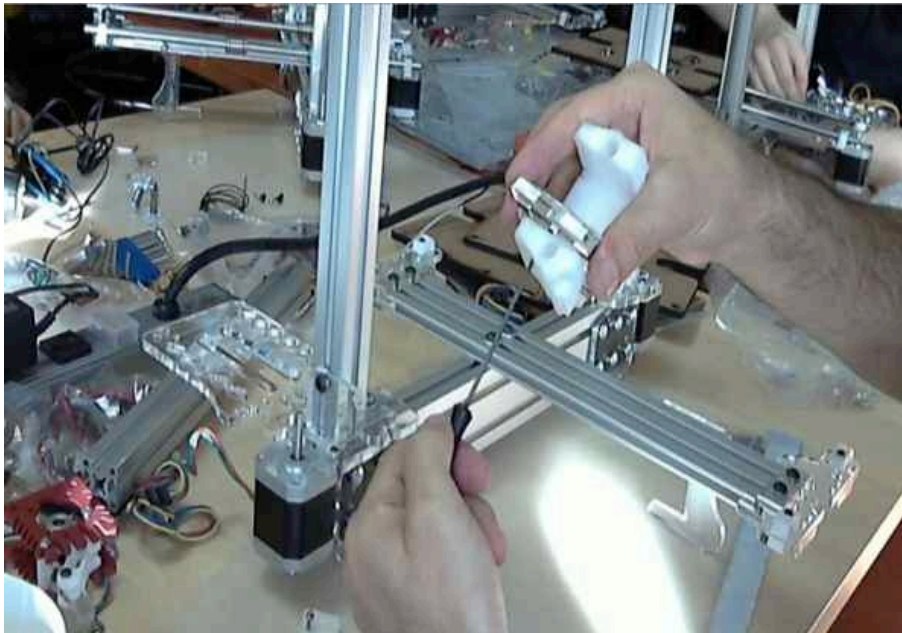

Wipe the vertical beams down carefully with a paper towel in case you have gotten anything sticky on them; it will be important for them to be very clean.

Take one acrylic piece with tape on it and use an M3 black screw to attach it loosely to one side of one of the X ends (white 3D printed pieces).

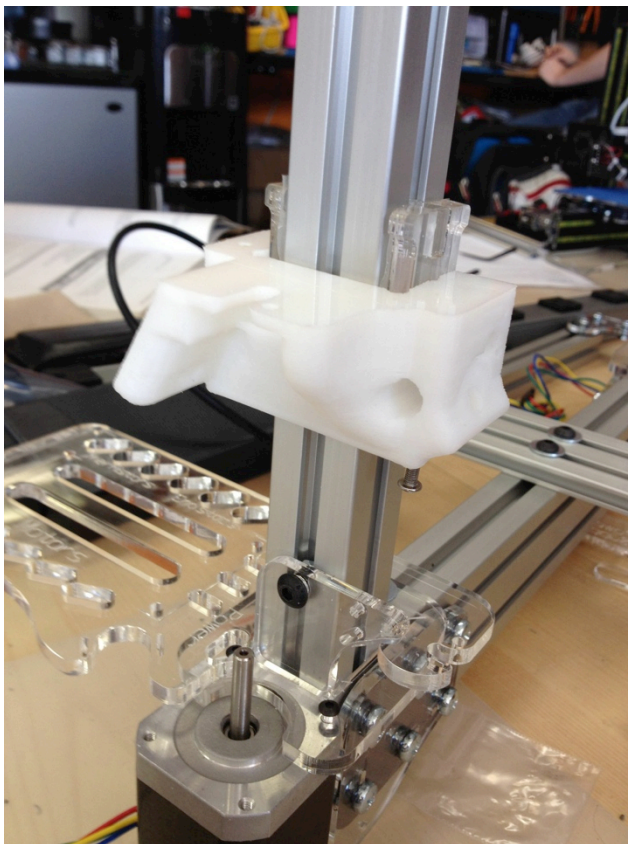

The relevant screw drops into the recessed holes on the 3D printed pieces as shown; you may need to ream the holes out a bit. The clear piece pokes out above the flatter side of the assembly. Put the piece with one of the taped slides onto the X carriage. Then slide the other taped piece into place and screw it on. The assembled set should slide easily but not fall down; if it is too tight, you can sand the white pieces slightly. The one with the downward-pointing screw is on the LEFT (side with the Azteeg mount board); that screw points down and will be the trigger for the Z end stop.

Take the X end that will go on the LEFT side of the machine (has downward-pointing screw) and add the X motor mount using the two M3 16 mm screws; drop the nuts into the recesses first and then screw in the screws. Leave the one in the slotted hole loose for now.

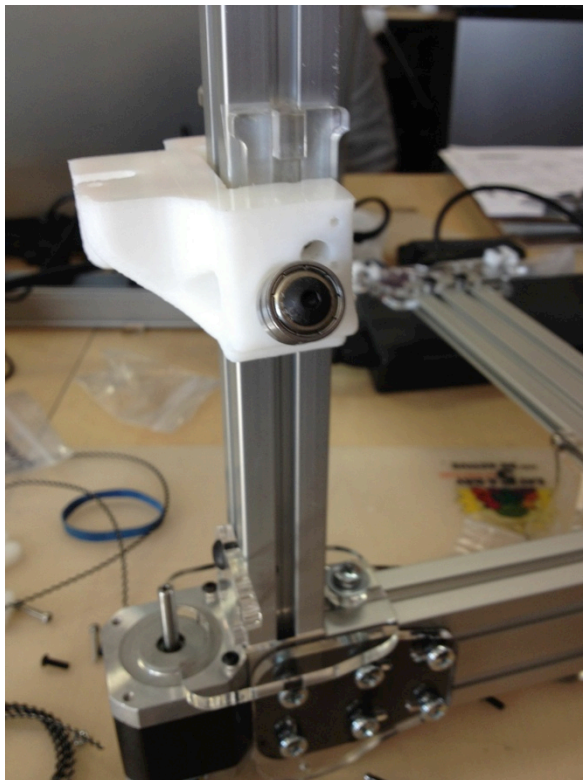
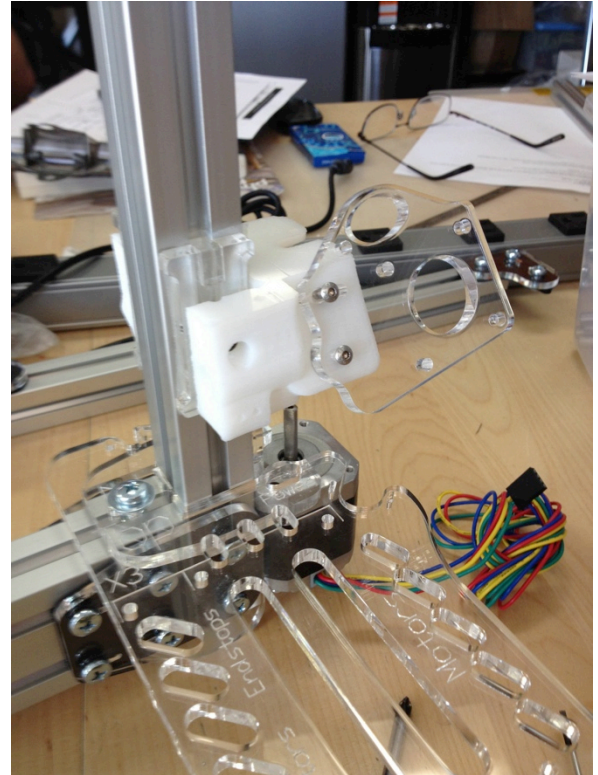

Open syncromesh kit.

Take 2 bearings and 2 washers and M 520 screw (black screw) from kit.

Load screw with bearing, then washer, then bearing, then other washer. Screw it into the X end on the back right of the machine. Set the rest of the kit aside for now.

Take X and Y rods (NOT threaded, 8 mm, 385 mm long steel) and wipe them off.



Assemble X and Y bearing rod assemblies.

Open XY Bearings Kit

Pull out 4 bearings. Put two bearings on each of the two Y rods.

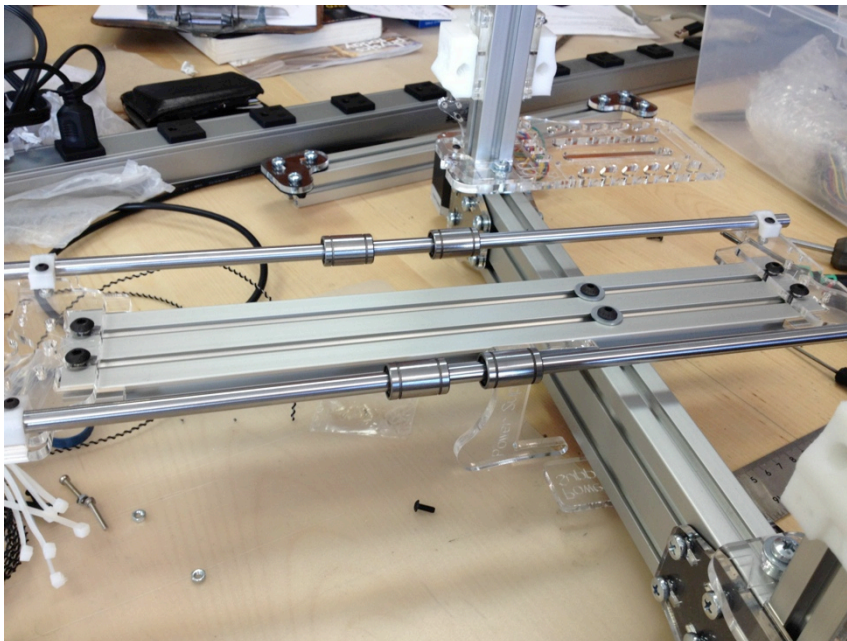

Insert the rods into the housing loosely on either end of the Y nylon end clamps. Be sure the clamps are loose so the rail will go in. Once the rods are in tighten the screws. The nylon should touch the acrylic once the screws are fully tightened.

Next clean two more rods. Put two bearings on each. Make sure the X ends are seated on the bottom of their Z travel so that the holes line up.

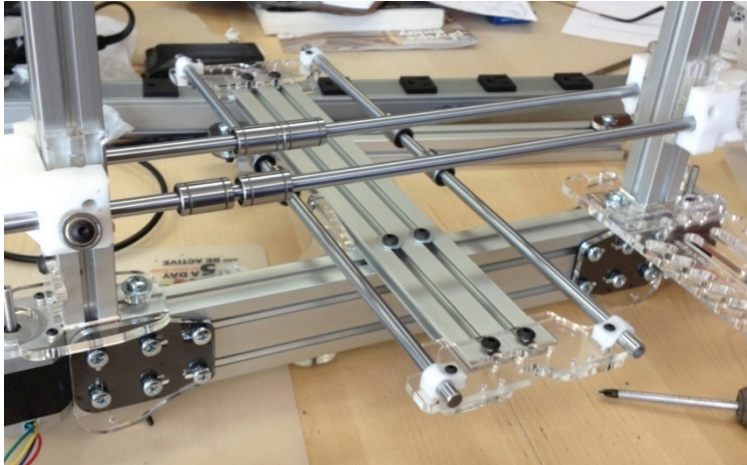

Run the rod through the holes in the X ends (these rods will be horizontal and perpendicular to the ones you just put in on the Y axis.) This will be the X axis rods for carrying the extruder. Be sure the rods extend well into both ends.

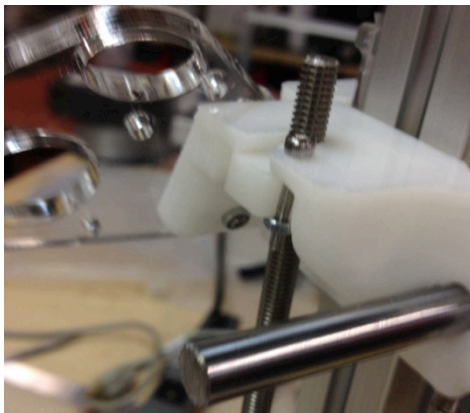

Z rods

Take the threaded long (320 mm) rods. Clean them by turning them in a paper towel. WD 40 is recommended.

Take the small square pieces (Z delrin nuts) from the x end kit and screw one onto the end of each rod. If they have a screw inserted already, remove it.

Insert the rod into the Z coupler

tube and seat it on the shaft of the motor. Attach the top of the rod into the 3D printed end stop. Add M3 screws on top plastic part- be sure the slot on the small delrin nut is lined up with the internal protrusion inside the hole in the x end (see photo). Repeat on the other side. Notice that the X carriage has to be lifted to get these on, but you should be able to do this without taking off the X ends. It's awkward to get the nut on- put it on the tip of a finger of your non-dominant hand, press the nut up against the bottom of the delrin piece, and screw down into it.

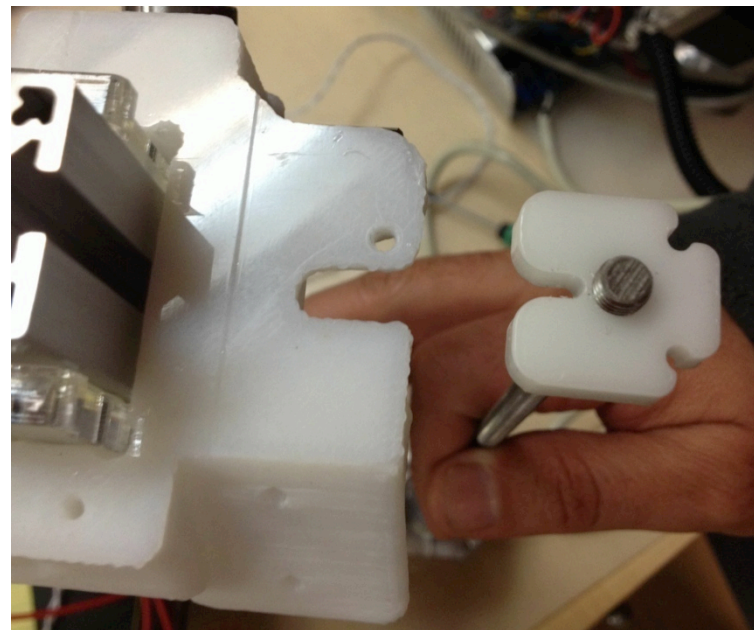

Open the **Y platform kit**, and find the Y carriage large acrylic piece. If there is brown backing paper on it, take that off.

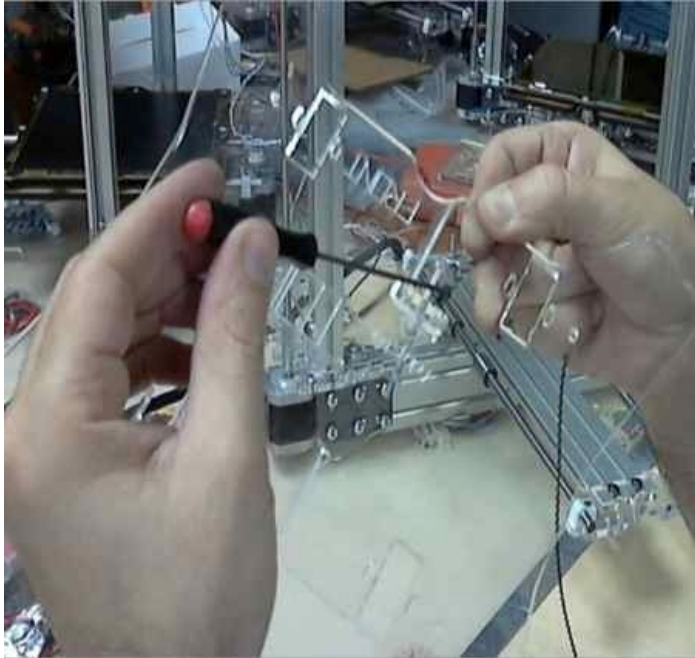

Take the part engraved "Y adj", and insert it into the Y carriage so that the protruding half-moon part is to the front of the Y carriage. This set of pieces will allow you to adjust the tension on the Y axis synchomesh. There is a diagram on the platform for you to follow.

Pull out a piece of synchomesh (both pieces are the same size). Thread it through the hole just in front of the slot for this "Y adj" piece and tighten the end with an M3 screw facing downward. Some pictures of these steps from varying angles follow (versus the picture from above here.)

The synchomesh has to protrude from the top front about a centimeter. The synchomesh will fit into a small slot on the side of the screw hole; there is a small indentation into the screw hole that the screw threads will bite into. Then thread the mesh through the Y adjuster guide holes, over the rounded 3d printed piece, and back.



The first part of the threading sequence from below (after your initial insertion of the synchomesh from the top.)

Note that this screw is what you will use to adjust the synchomesh tension later.

We are showing looping the synchro mesh around the half-moon protrusion.



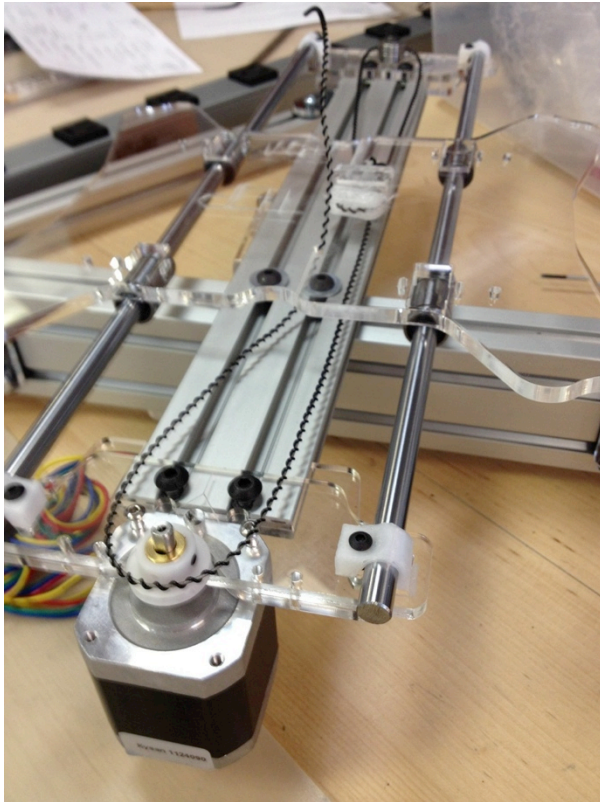

Put together another screw assembly with washer/bearing/washer/ bearing and attach it to the end of the Y carriage away from the azteeg board carrier. It should be tight, but not enough to break anything.

Take one of the motors and attach it to the end of the Y axis on the back of the machine using the M3 12 mm screws left over in the Y ends kit. You might have to loosen some of the other screws to align things; tighten all when the motor is on. The wires should face inward, (toward the front of the machine, toward the top of this picture). Place the synchronesh pulley (white) on top of the motor shaft.

Be sure the set screw on the pulley (little black screw) is matched up with the flat side of the shaft.

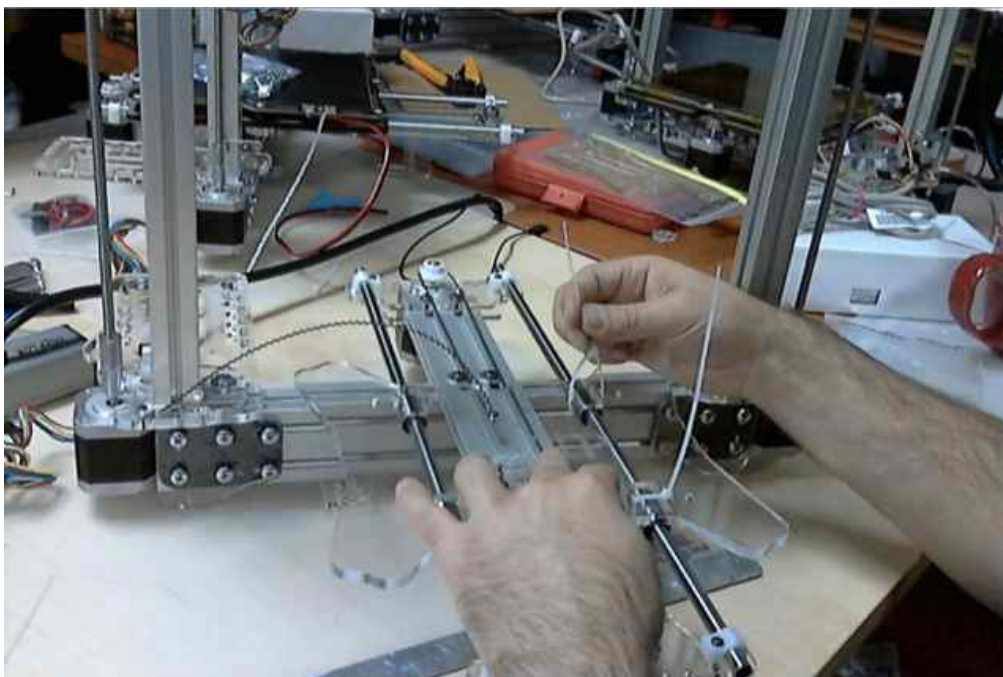

Take two zip ties and zip tie down just the left-side bearings. (Leave the right side for now so that you can have some access.) Be sure that you have not crossed over the synchronesh under the platform.

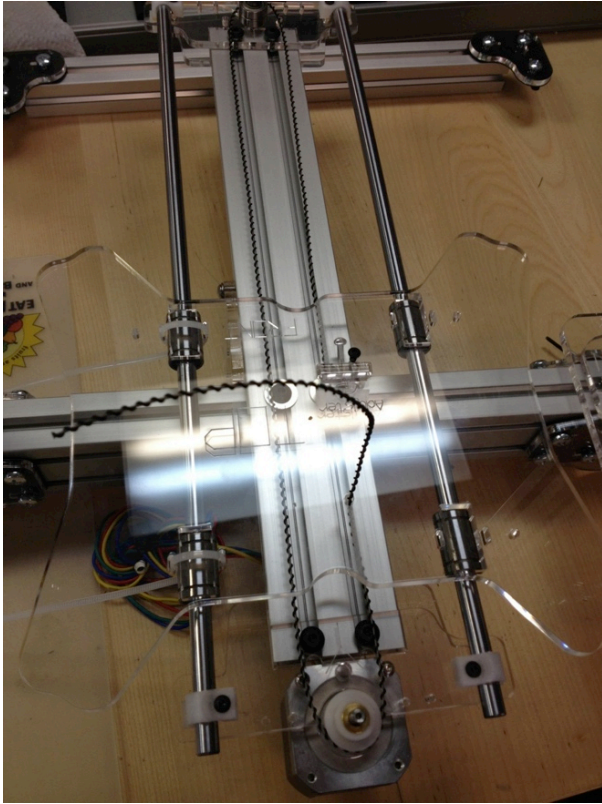

Take the Y-carriage acrylic piece; the “front” marking is away from the azteeg board mount. Run the synchronesh cable through the back of the board and through the pulley on one end of the y carriage and the roller on the other end. Attach the other end on the middle of the platform by pushing a screw into the provided hole as you did on the other loose end. Pull the synchronesh to make it tensioned but not extremely tight. There can be a little play in the synchronesh, but only a little.

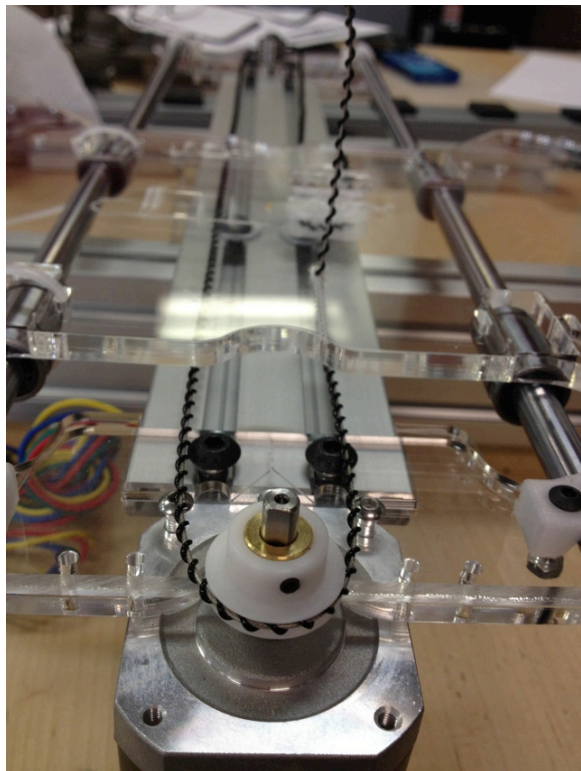

Add the zip ties on the other side. Tighten down the platform by pulling on the zip ties and make it tight. Once they are all tight trim off the excess. Do not trim the synchronesh; you will tuck the excess away in a later step in case you ever need to disassemble the printer.

Tighten the sychromesh with the adjustment screw under the platform. Make sure that the cable is not touching the acrylic platform. If it is, adjust the pulley downward until it is clear. The picture below shows the adjustment being made on a completed machine so that you can see where the adjustment screw will ultimately reside.

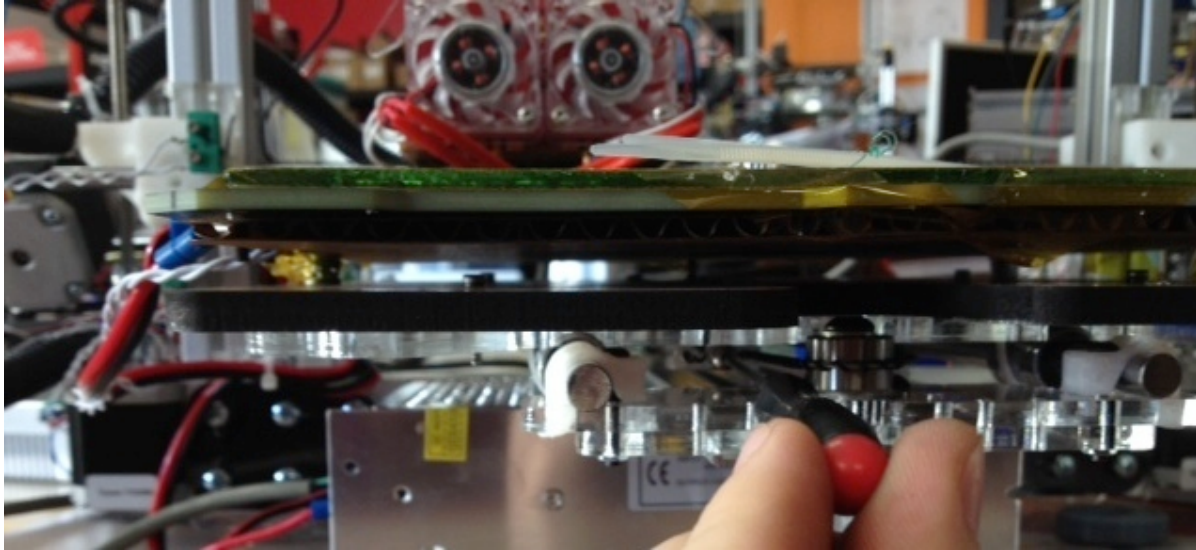

Attach wooden platform.

Take the wooden piece. Put in the endstop screw (M3 x 16) , which is in the **Y platform kit** package. This is the y endstop. Screw it in all the way- it does not get a nut on the back.

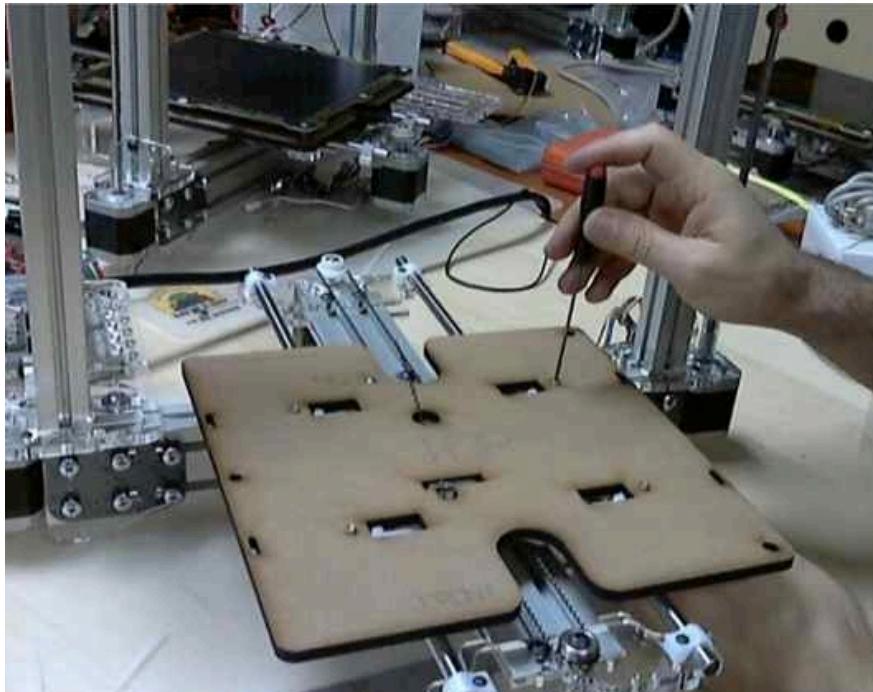

Now take the other four M2.5 screws and nuts and use them to attach the wooden platform mount to the clear platform support you just put on. Be sure the "Front" label is on the side away from the azteeg board support and be sure they are very tight. Check that the assembly slides smoothly.

Attach heated platform (and cardboard)

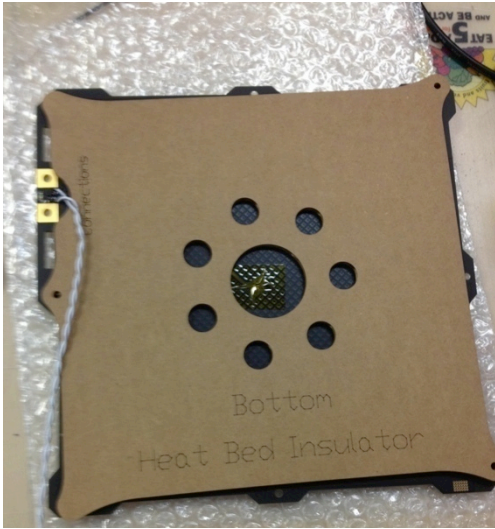

Pick up the heated platform assembly and piece of cardboard. The cardboard is an insulator to make the platform more efficient in holding temperature.

Get the platform adjuster wheels from the **Y platform kit** (looks like a flower on a screw with a spring.)

Take the screws from the adjuster wheels and screw into the heated platform (check the cardboard to see which screw holes to use-- put the screws in the two corners away from the cable and the closest hole to the cable.) Place on the platform with the cable on the side nearest the Azteeg board (on the left, looking at the machine from the front.)



Put a spring in between the heated platform and the wood board. Run the screw through and put the flower adjuster ends on the bottom. Tighten all around. Fully compress the springs for now (you will back these off to align the platform later.) Set the glass piece aside- you will put that on top at the very end of the process.

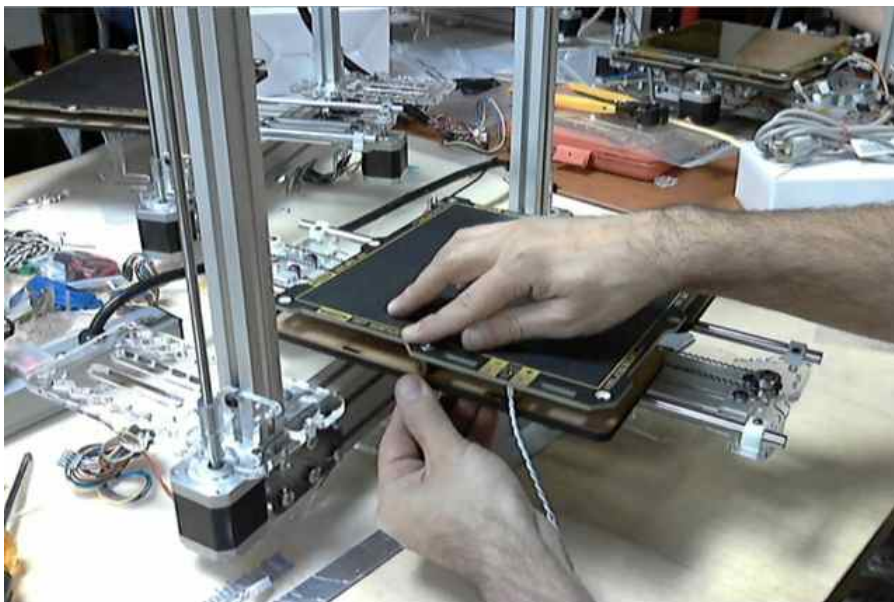
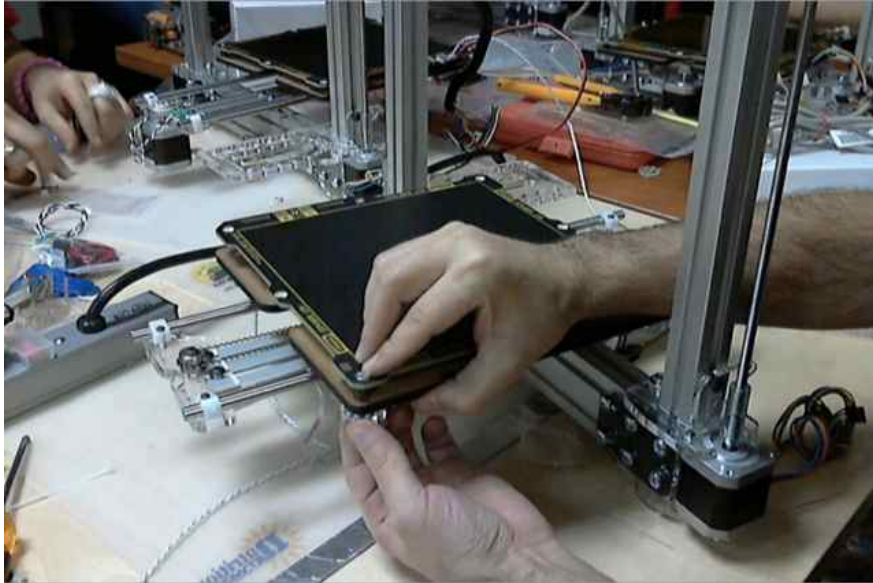

Assemble the X carriage.

Open the **X carriage kit**.

You are now building the assembly that will carry and move the extruder in the x direction.

Attach the two plates one above and one below the rods. Attach with central screw. Tighten firmly but not excessively. Be sure the bearings dimples are in the grooves in the carriage. The single hole is toward the back of the machine(if you prefer, it looks like a smile face from the back of the machine.)

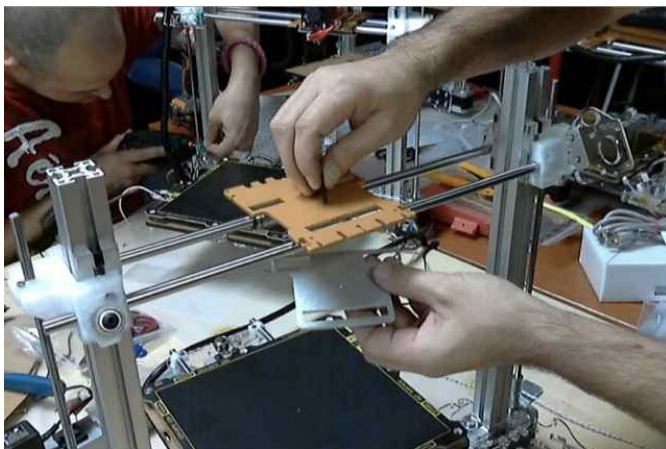
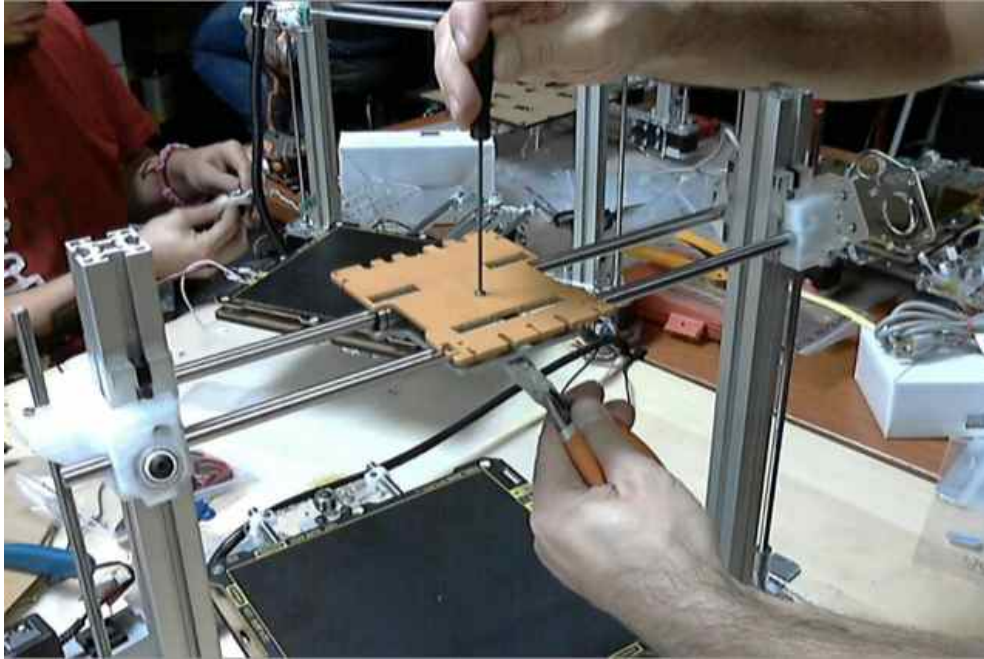

Assemble the extruder(s).

Open the **nozzle kit(s)**. Take out the nozzle and the heater cartridge (thick wires with connector). Insert the cartridge into the nozzle assembly as shown. Be sure the white plastic filament release is on the same side as the nozzle. If the thermistor wires (single wires coming out of the heater block) are not stripped, strip the loose ends.

NOTE: To learn to strip wires, see tutorial on instructables.com or your favorite Maker site. Be sure that you do not strip the current-carrying wire- just remove the insulator.

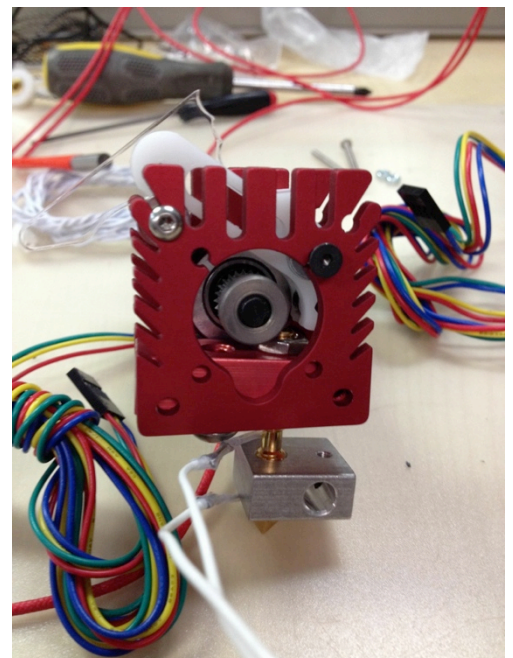

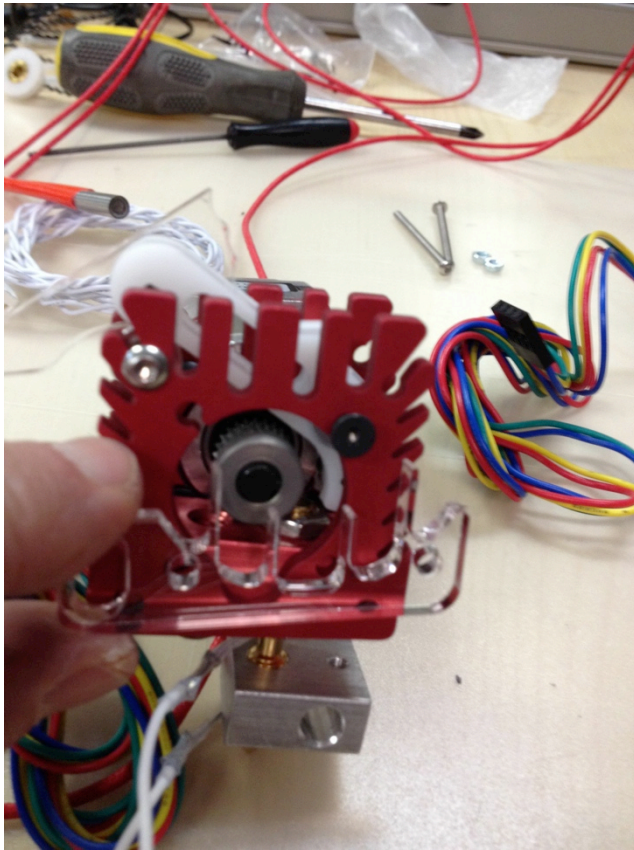

Next comes the fan spacer, and finally the fan. The fan label faces inward (will be hidden after assembly.) Screw together with two M3 x 40 mm button head screws.

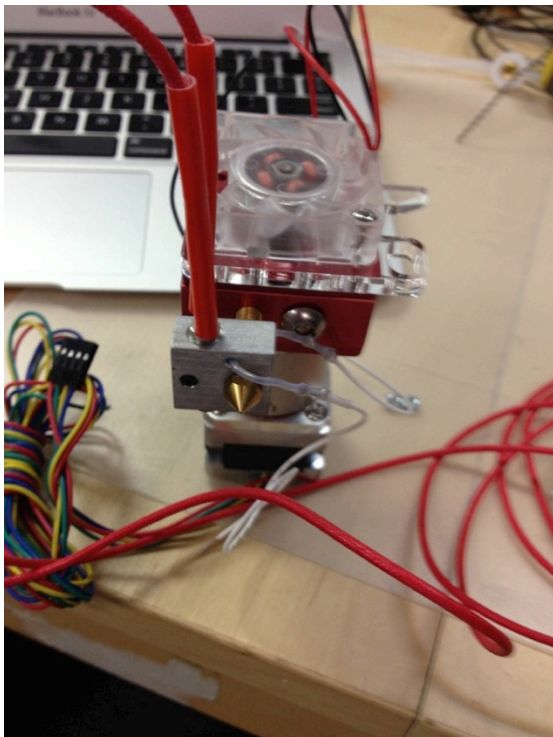
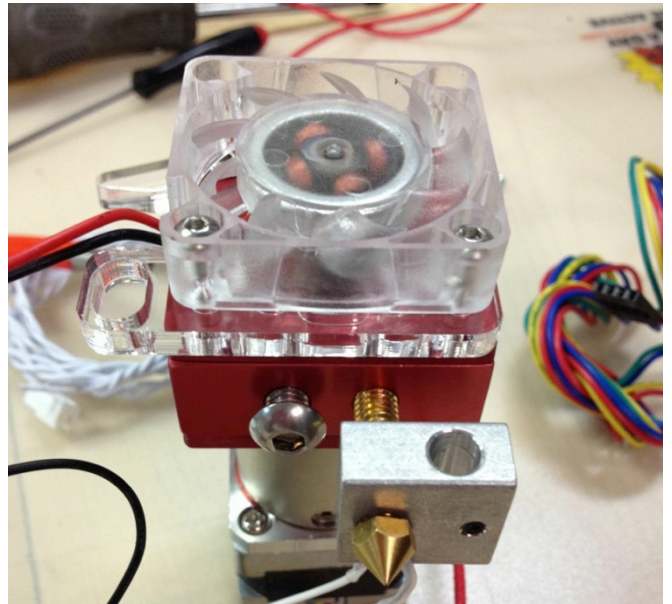

After you have attached the fan, then insert the heavy red wires into the heater block as shown.

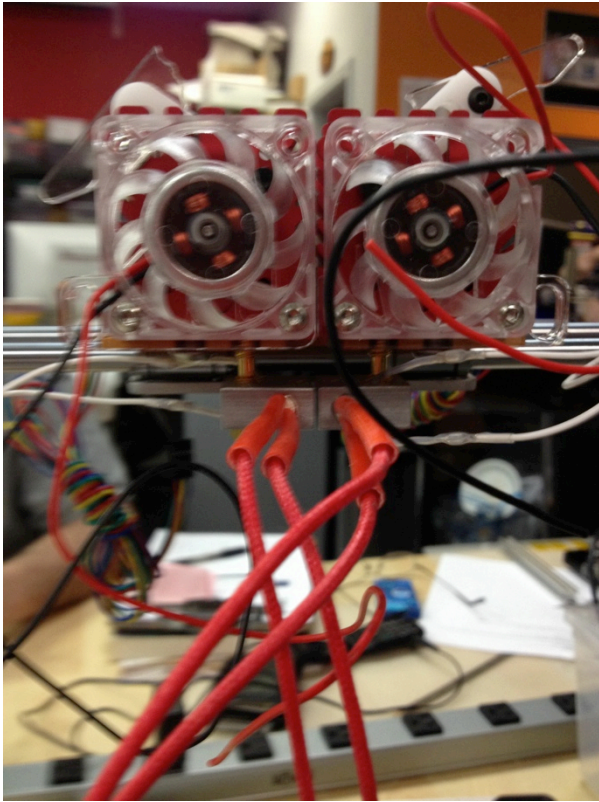

Then mount the extruder(s) onto the mount on top of the bearings as shown. If you have a single extruder, it will be on the right. Duo is as shown.

For a single extruder, place the extruder centered in the x direction. If you have a dual extruder, one cartridge will be on either side of the centerline of the plate. In either case be sure the thermistor cables come out of the front and are not pinned under the carriage. If you are doing a duo (shown here) the heater block is reversed in the two nozzles such that the filament clip is above the nozzle.

Open the **extruder connection kit**.

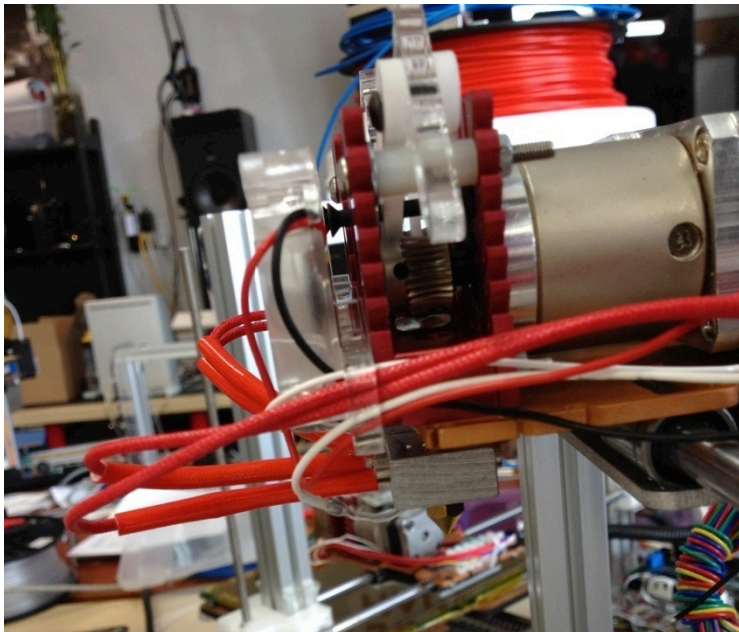

Take the terminal connection block (plastic piece with 12 slots with screws to hold down wires). Take the thermistor and fan wires and run them through the guides on the sides of the fans to the back of the extruder motors. (Side view shown here.)

Now you will wire the part of the connector box that will take the extruder inputs.

Put the red wire from the fan into one slot and the black wire into another. If you have a duo, put both red wires into one slot and both black wires into another. Twist the ends together.

Run the thermistor wires from each extruder into two slots (total of four slots for a duo) and screw them down. The wires have no polarity and the order does not matter.

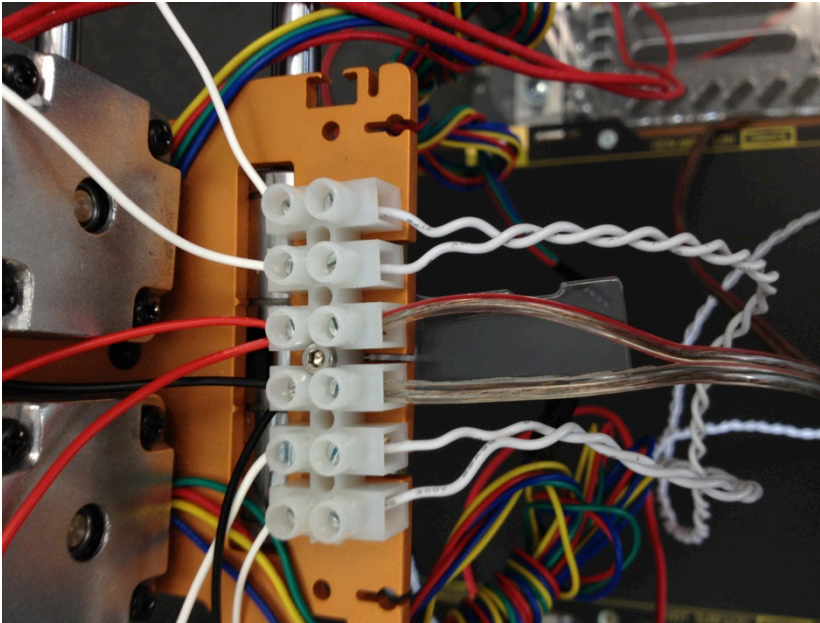

Now we will start the other side of the connections.

Take the wire with two pin connector (long thin wires) and strip the end away from the connector if they were not already stripped. Normally this wire is twisted. (Do NOT cut off the connector though!) These wires will connect one to each thermistor (just one if a single, two if a duo.)

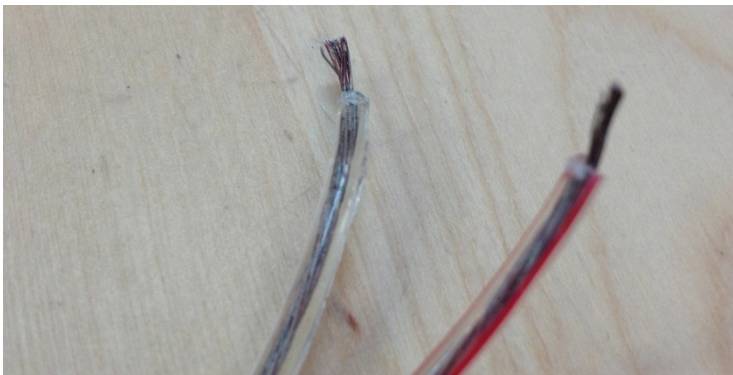

Take the 22 gauge wire and strip the ends. Split one end as shown for two or three inches. Connect the red end to the red fan wires, and the black end to the black fan wires. (The fan wires have a polarity.)

We suggest (in the case of a duo) putting the thermistors on either end and the shared (fan) connectors in the middle. The extruders are on the top of this picture. The connections coming out will go to the main electronics board.

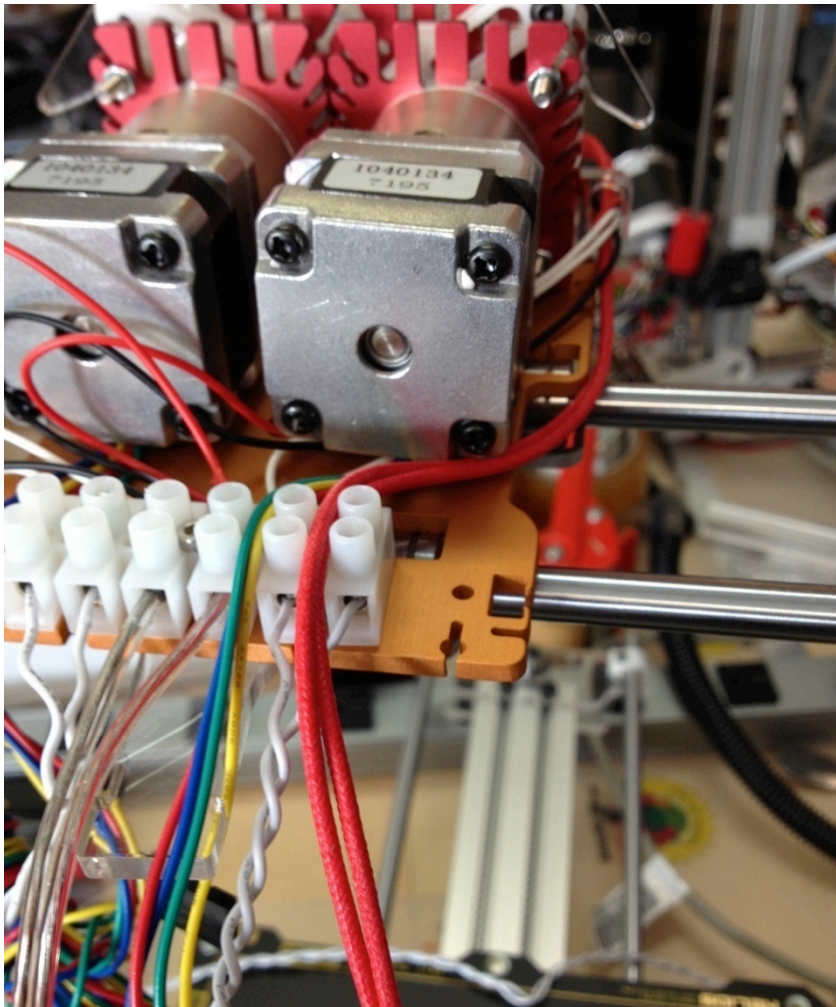
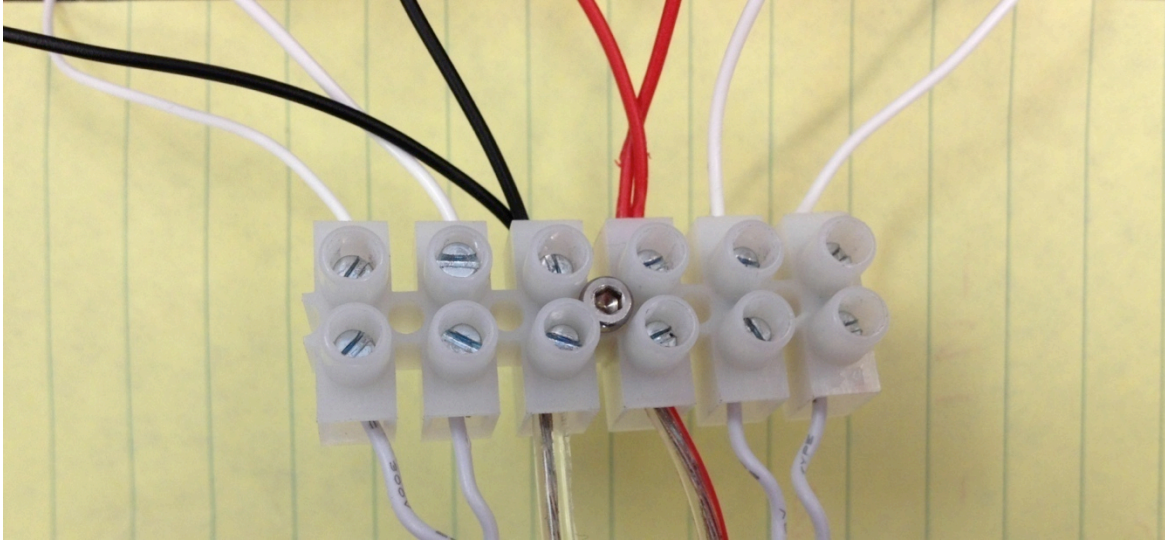

Screw the connector block onto the metal extruder carriage with the M2.5 x 16 screw and nut provided, with the small clear acrylic part below the carriage.

Now tidy up the wiring; run the wires under the extruders and tuck the heater wires in-between the top terminals so that things will not catch on the sides when the platform moves. Make sure no connections are loose and no wire strands are exposed.

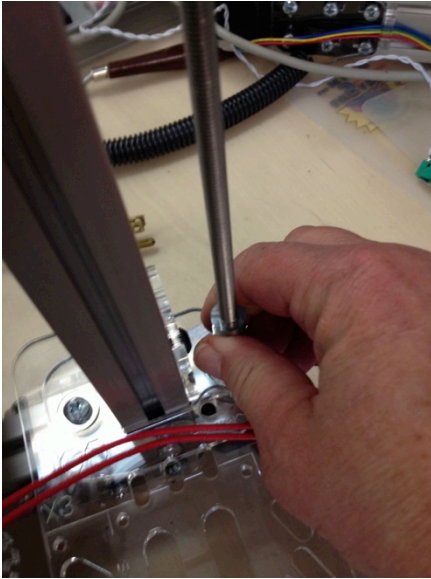

Next we will put on the top beam to finish the frame. First though you will need to lower the carriage by twisting the vinyl tube couplers over the Z screws on both sides.

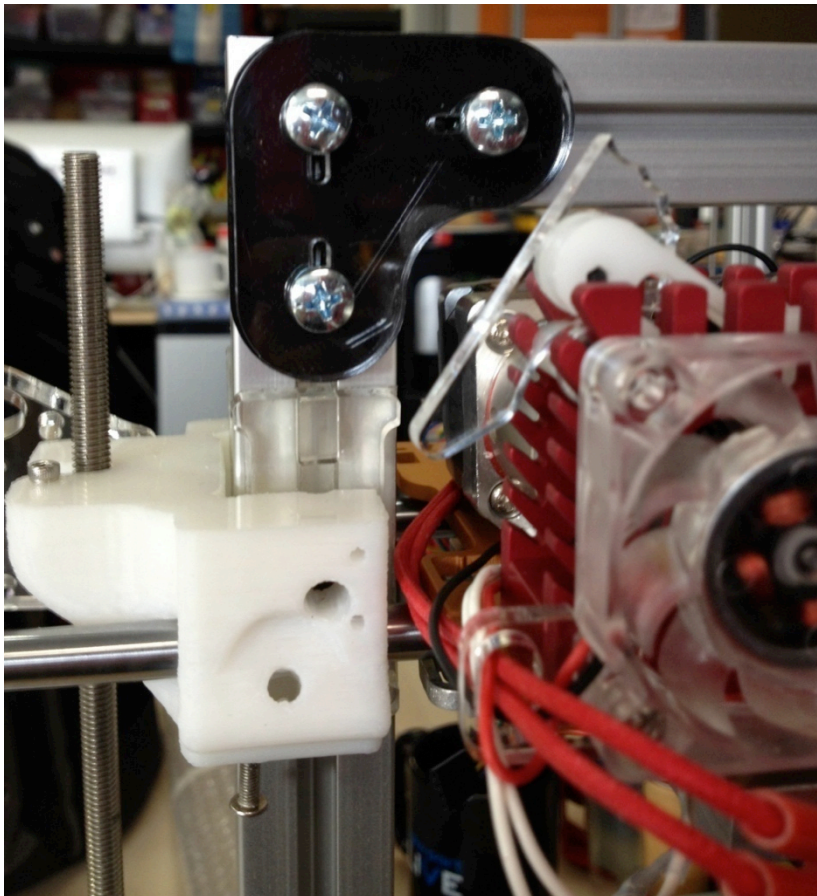

Be sure that the x ends (including the protruding acrylic sliders) are clear of the corner brackets. Check that the top is flush and there is no gap between sides and top. Tighten down the brackets.

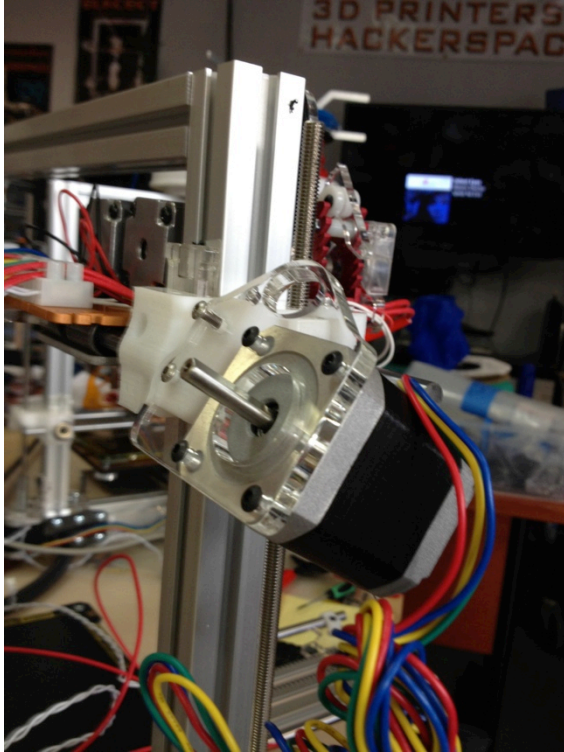

Install X synchronesh and pulley.

Get the X motor. Put X motor in acrylic holder with M3 screws from X end motor mount kit. Tighten the motor mount into place skewed upwards for now, with wires pointed upward for cable management. Put pulley on shaft.

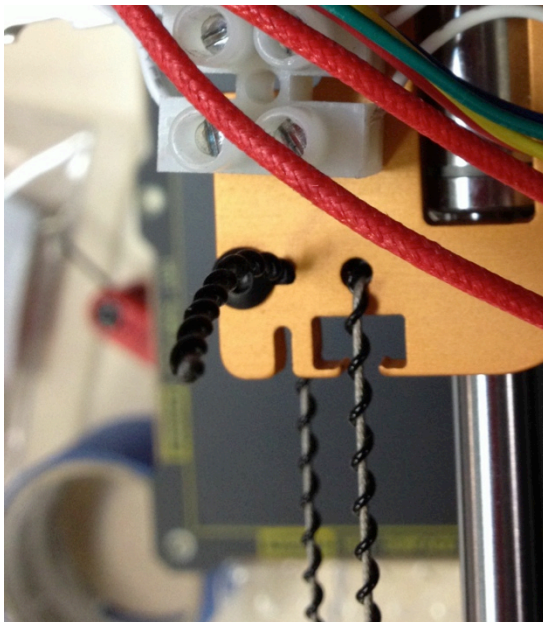

Thread synchronesh through holes in the x carriage and crimp down the end with screws from synchronesh kit. The synchronesh should go DOWN through the circular hole, then come UP through the slot with the screw. Tuck the excess into the slot on the side of the extruder carriage, or cut it off. If you cut it be sure to leave at least 25mm in case you need to reassemble the machine later.

Thread synchronesh around pulleys and drive, and then connect it to the other end of the carriage with another screw. Check that it is in tension (but not tight.) Adjust synchronesh drive pulley placement if needed to have the synchronesh pulling straight.

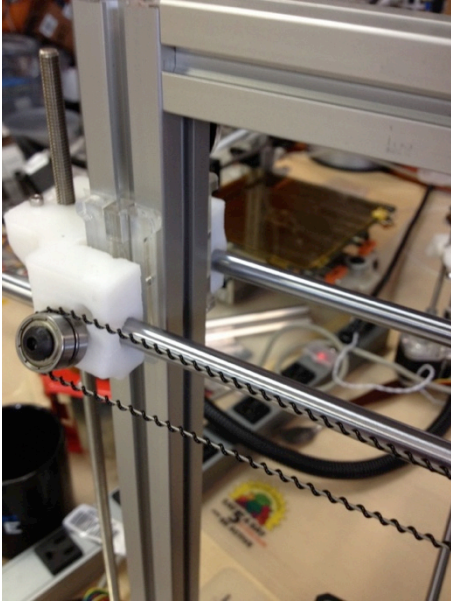

When that is done loosen the motor holder and swing it down which should add some tension. If it's too much, loosen slightly by loosening the tiedown screw. Cut off excess synchronesh once tension is correct.

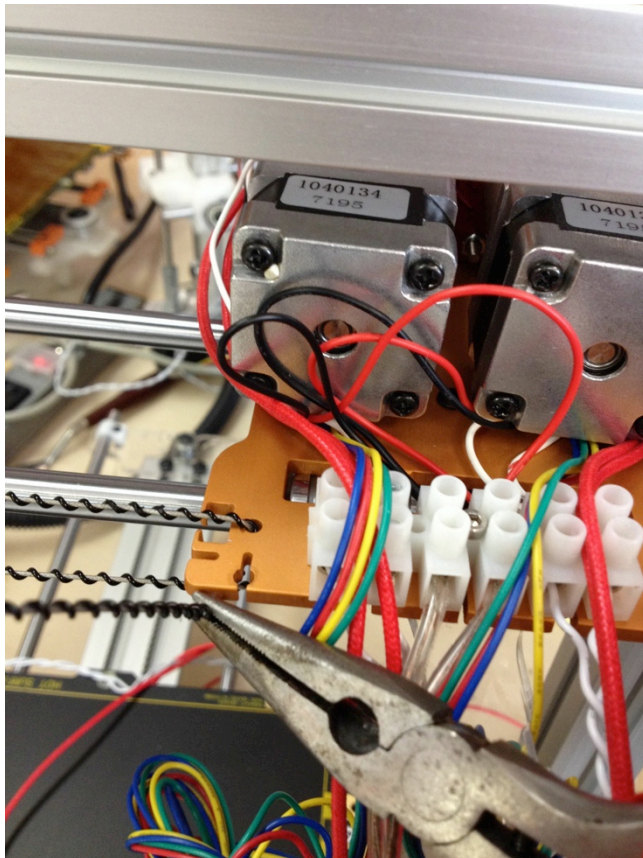
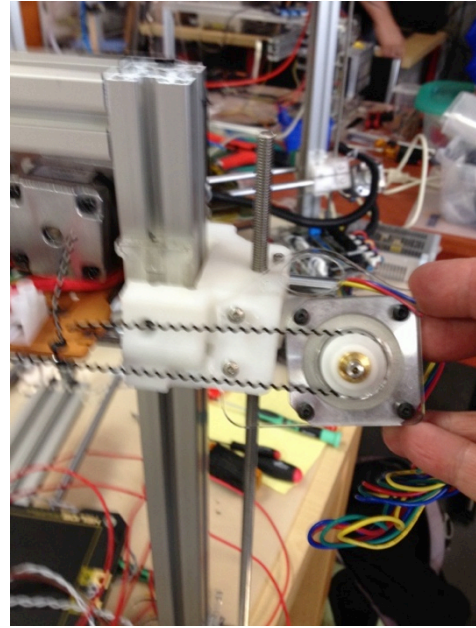

If you are having trouble getting it tight enough you might use a pair of pliers to pull the synchronesh up out of the second hole. Tighten down X carriage motor mount when done.

Cable management.

Now we will do final cable management. If you have a dual extruder (shown here), mark all of one of the extruder's cabling (power, heater, thermistor) with a bit of tape or a sharpie. Mark the end of the X motor's cable before tucking it in, too. Put the cable into the covers.

Run the wire bundle through the hole in the motor mount on the left X end and put on the conduit tubing. Make sure that the carriage can move end to end.

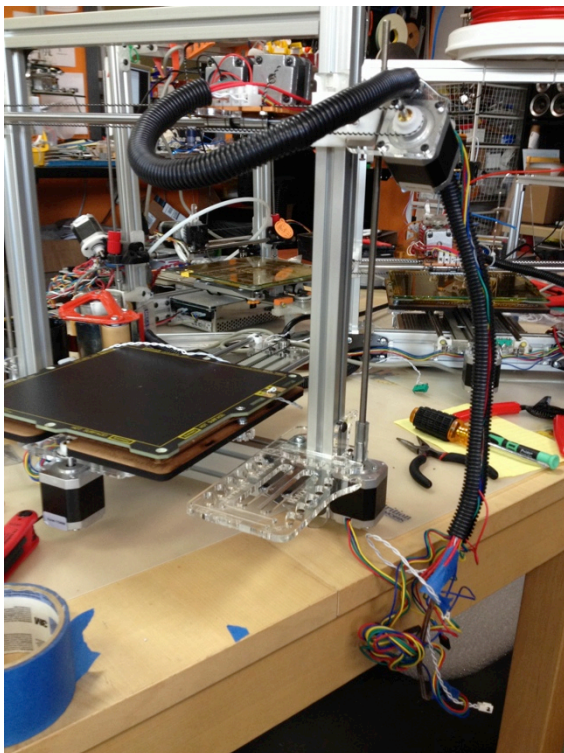
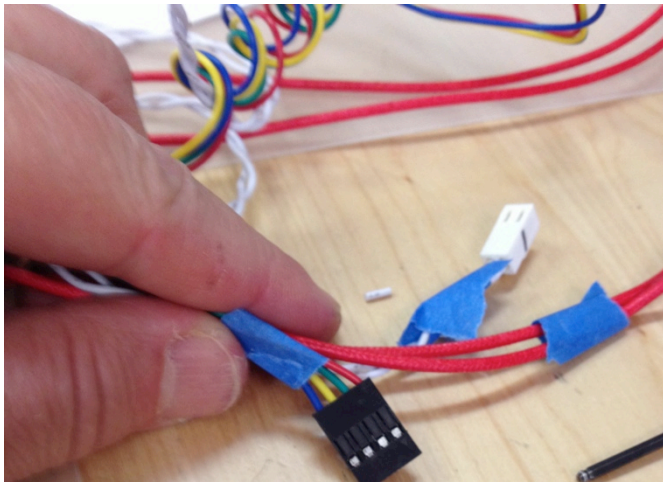

Place end stops.

Open the **end stops kit**. Label both ends of one X, the next one Y, and finally Z. If one is a little shorter use that for the Z axis.

Take your Y end stop (small switch) and put it on the motor end of the y axis – put the spacers below the end stop first

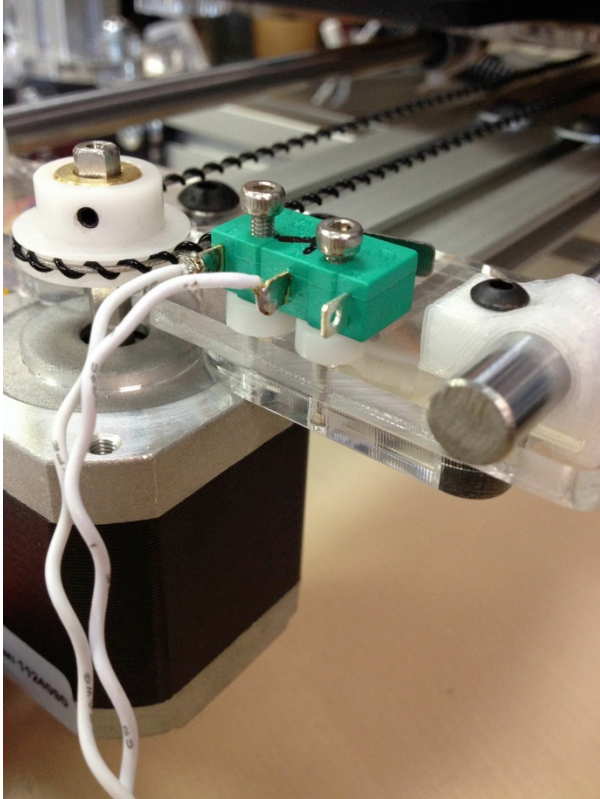

Assemble the screw and spacer. Screw down the end stop.

This end stop should be triggered by the screw on the wooden platform support. Check that you have labeled the connector on both ends so that you can remember which connector goes where (this is the Y end stop.)

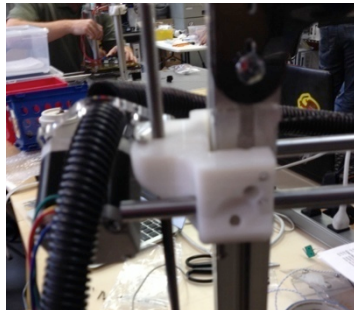

Next assemble the X end stop just like the y one. It will go into two small holes in the left-side (motor side) X end. These holes are hard to see; this picture has highlighted them with a marker and

you may want to do the same. Gently ream out the tip of holes with a smaller driver than the screw before attempting to attach the end stop if you can't get it started. Make sure that the platform triggers the stop. Run the wires through the conduit tubing.

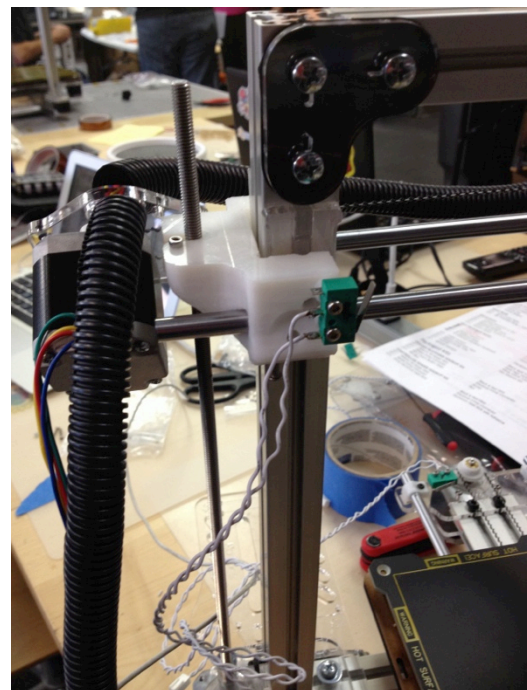

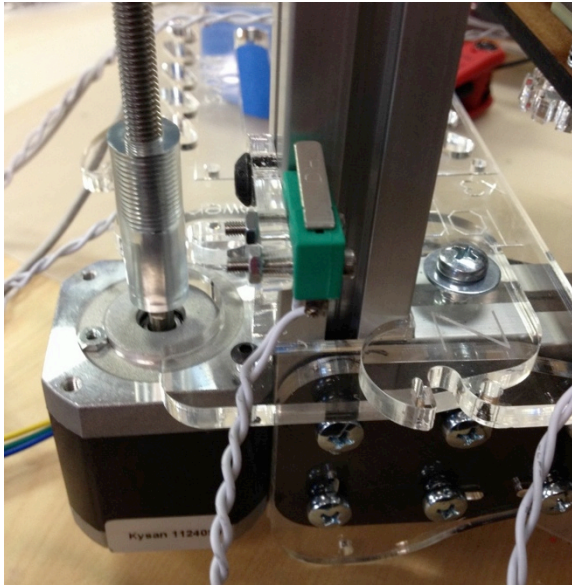

Now assemble the z axis stop. It will attach to the Z motor vertical support on the Azteeg board side below the X motor. Screw in and fasten with nuts. Be sure this stop is stiff and well-mounted since if it is not your first layer may have issues.

Wiring up the controller.

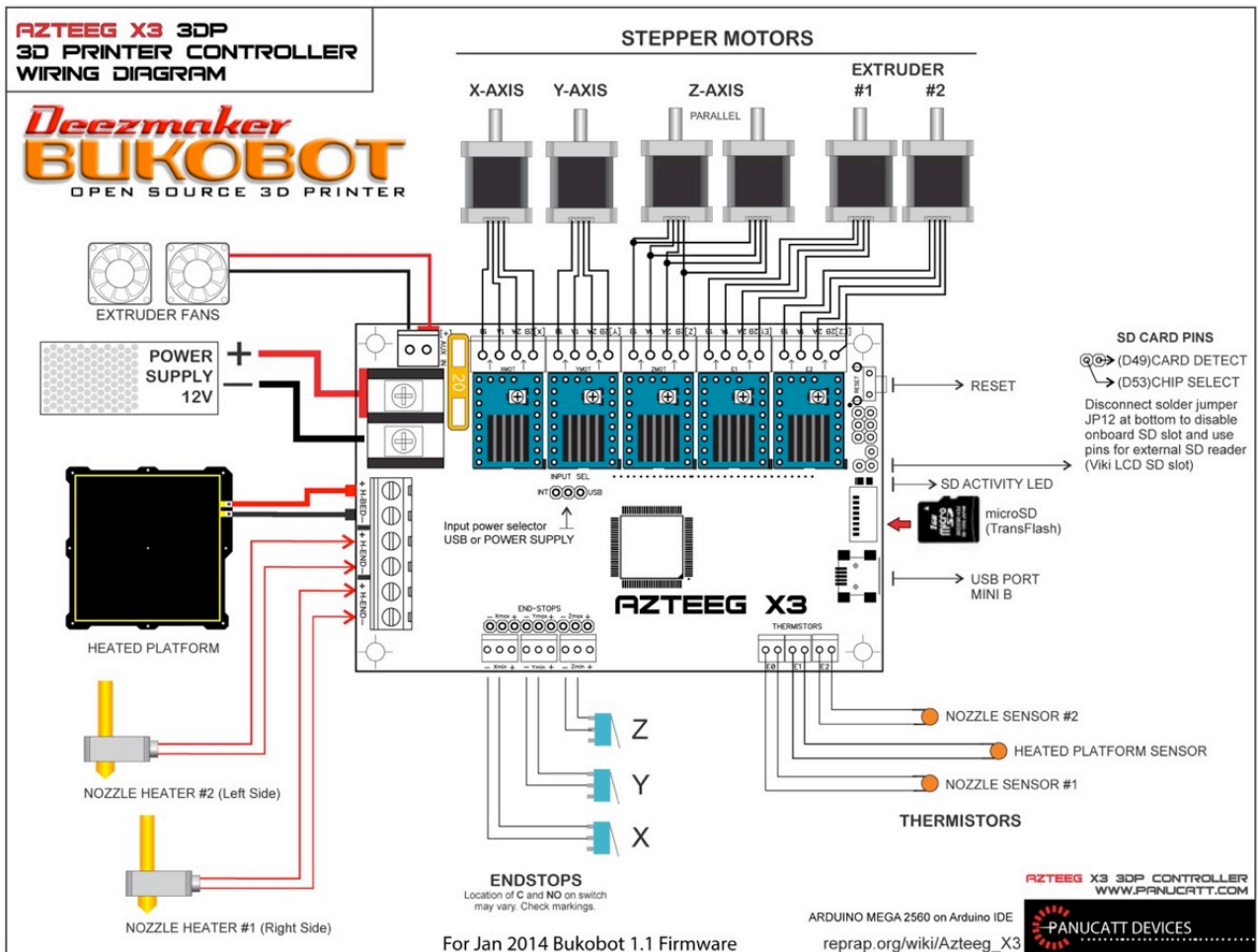

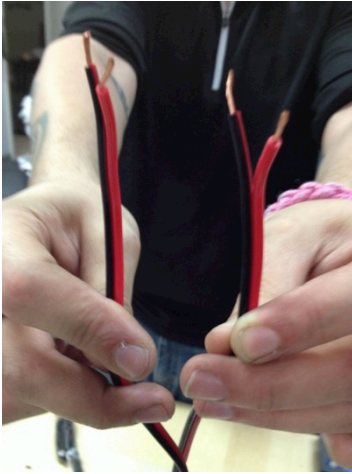

Take the controller power hookup kit. Strip and separate both ends of the red and black wires.



Crimp connectors on six of the ends (leave one set with just stripped wires at one end.)

Run wires through the labeled holes on the connector board mount as shown and clip connectors from the various components into place on the Azteeg board carefully.

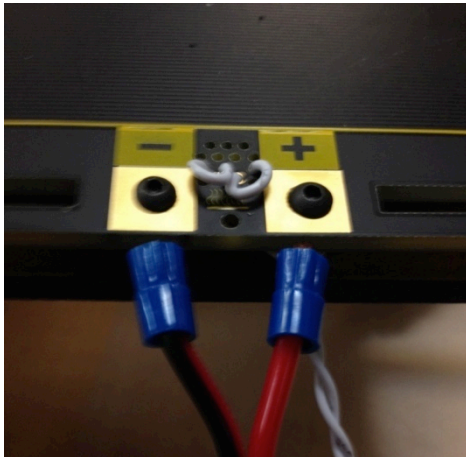

Take the red-black power wire pair that only has connectors crimped on one end. Connect the crimped end to the heated bed, with red wire going to +. Use the remaining M3 screws and nuts from the heated platform hookup kit.

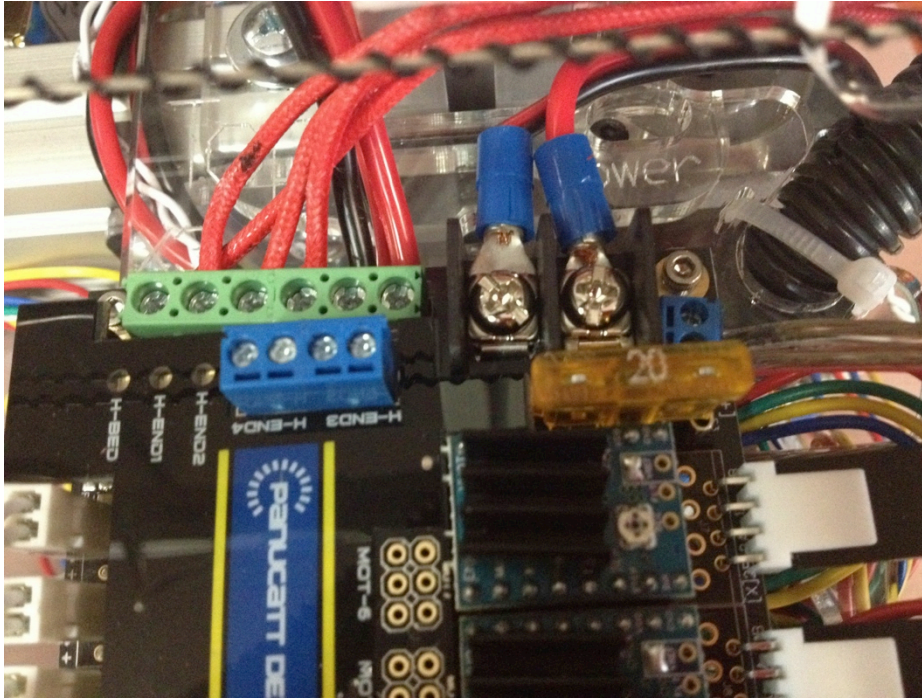

Strip the ends of the extruder heater wires and insert them into the “H-end” pairs on the Azteeg board (if you only have one extruder, just use #1). Since these wires are not quite long enough to go down and through the connector board mount, you should separate them out a bit higher than the end of the cable conduit and run them across the TOP of the

mount.

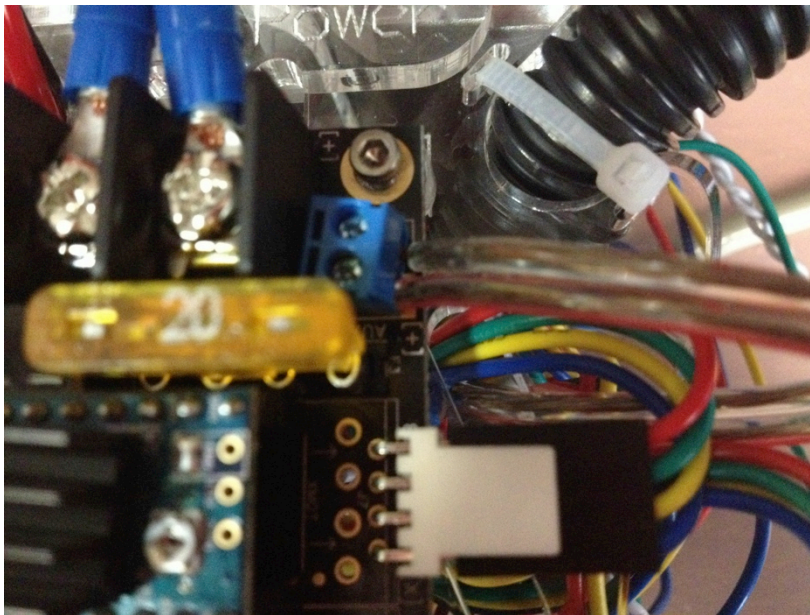

Attach the main power wires to the big screws nearest the z axis bar (at the top of the picture).

Note the cable tie holding down the conduit. Putting on this tie is described later; the finished machine was photographed here.

Attach the fan wires (be careful to hook up the red end to +) to the small blue screw-in connector box labeled “aux.” (It is on the upper right of this picture, just below the screw

in the corner of the board.)

The six motors connect on the outside of the board (far left of the machine.) Be careful not to mix them up!

Gently tug on all connectors to be sure they are in securely and be sure there are no loose wires or strands of wire.

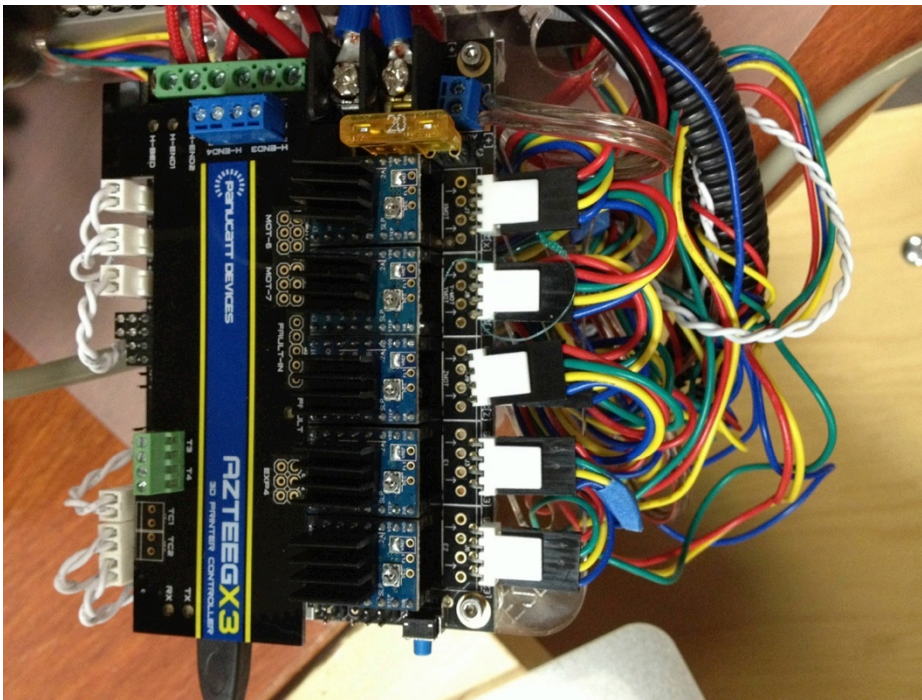

Once you are satisfied all the connections are correct and secure, then attach the controller board with the spacers, screw and nuts.

Add the heat sinks to the board (take off the sticky backing; one per chip.)

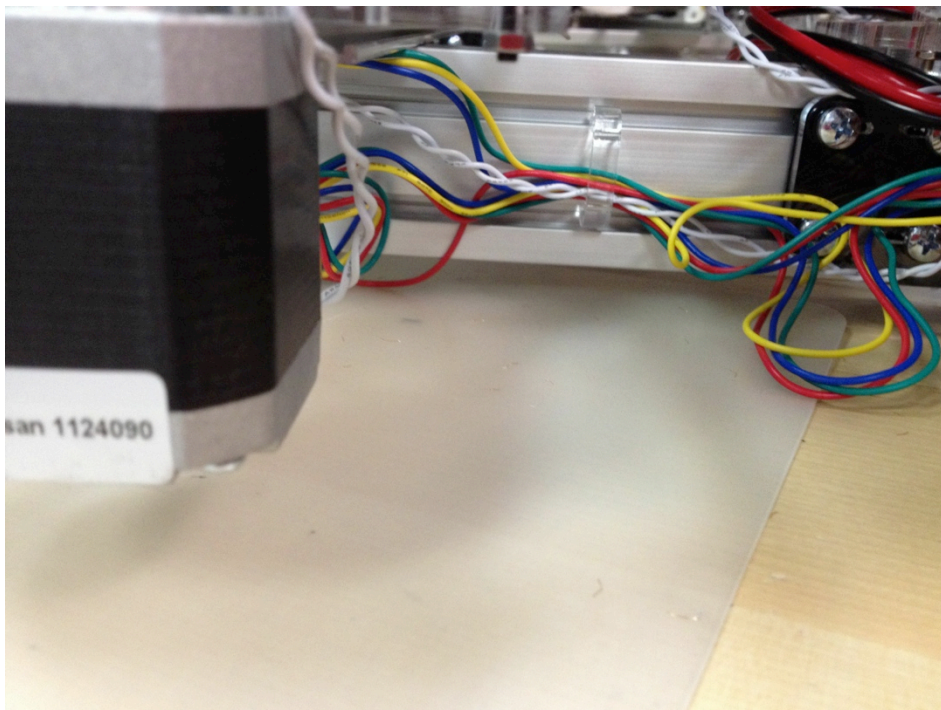

Tidy up the cables under the machine with the clear clips.

Attach the power supply.

Take the power cord and very carefully strip the end and crimp on three connectors.

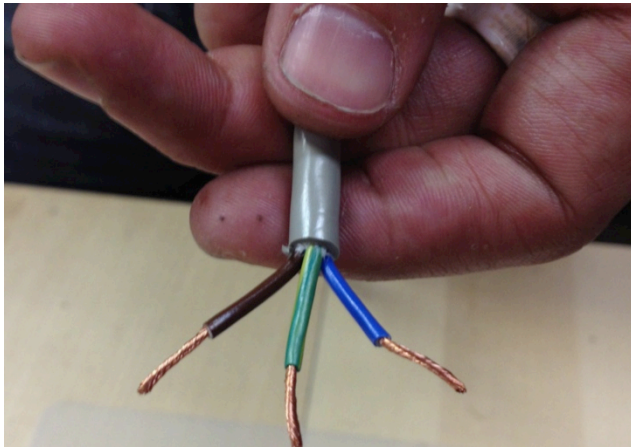

Pick up the power supply. Move the switch to 220 V or 110 (US), as appropriate.



Attach the power from the Azteeg board black to any COM attach point and red to

any V+ point (all are equivalent.) Attach the power cord connections as follows: brown to live (L), blue to Neutral (N) and green to ground (see image.) In this case the “black” wire still had some red insulation on it. Be careful that you are using the right wires.

Put the terminal cover over the terminals on the power supply (it is just a press fit.)



Attach the power supply to the machine; be sure it is solidly attached. This is the view from below the machine.

Check that the frame is square. If you don't have a square like the one shown here, use the corner of something solid.

Check the solidness of the frame- tighten down the critical screws and check that the frame doesn't wobble when you pick it up. Make sure nothing has fallen off or worked loose during later stages of assembly.

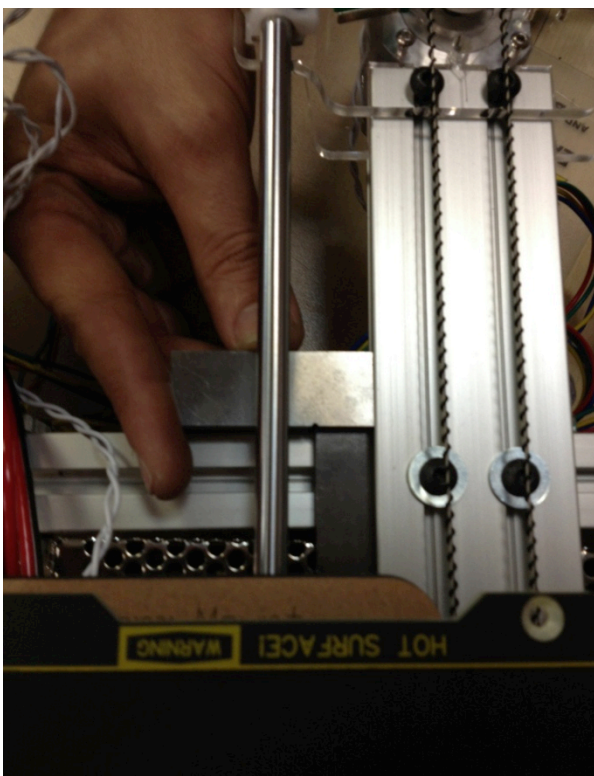

the loose wires. There are strategic holes in the frame to accommodate the cable ties. the wires coming off the X carriage, attach the cable conduit to the plastic strain-relief piece as shown.

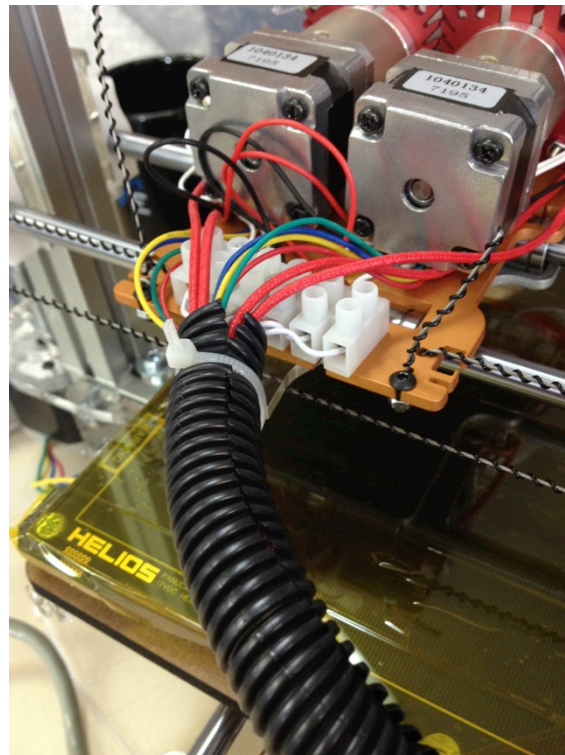

Use cable ties to tidy up in the For

In other areas, think through and anticipate the farthest range of travel in each direction and be sure the cables will not bind or catch on anything when the machine is moving.

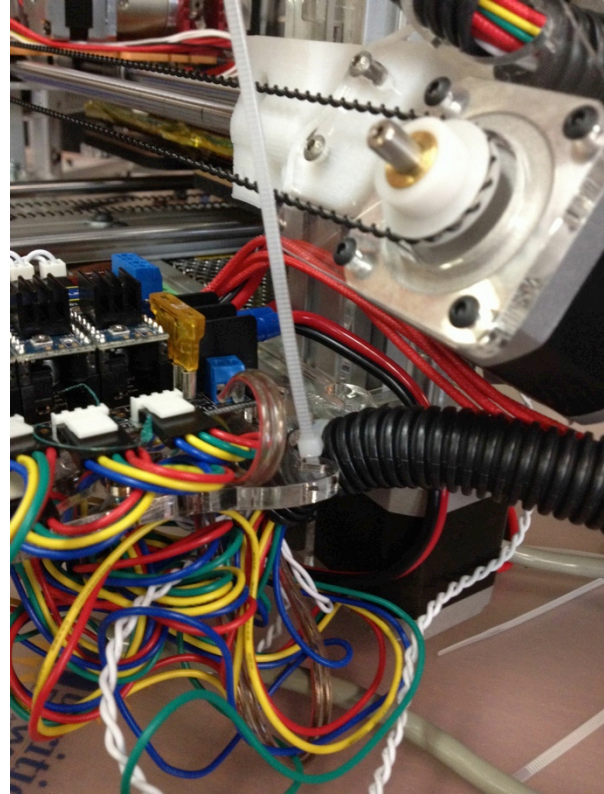
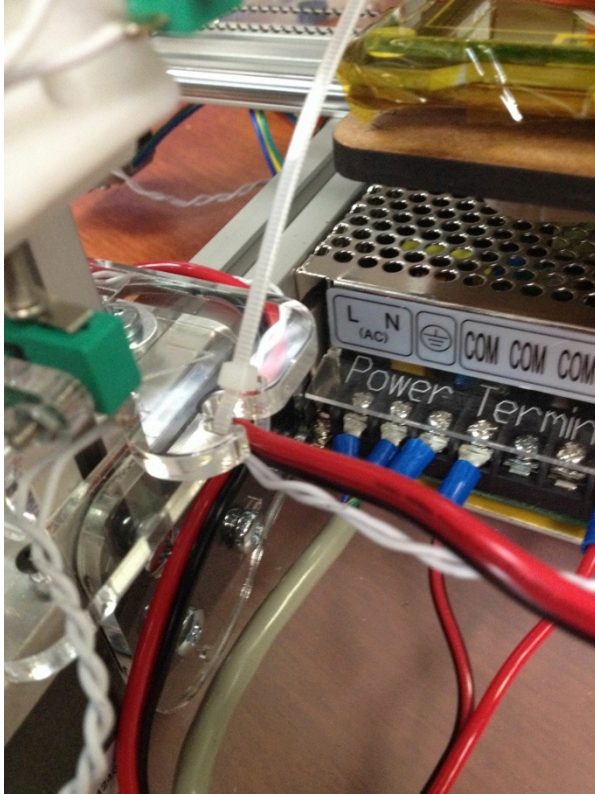

Attach glass sheet and platform tape

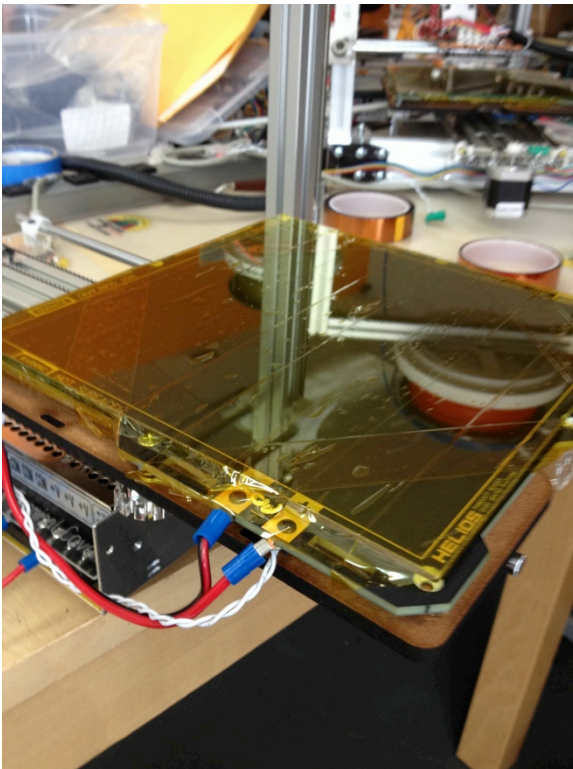

Take the kapton tape (yellowish clear tape) and the sheet of glass and tape the glass down on top of the heated platform. Cover the entire platform without gaps or overlaps. This is the surface you will use for printing most plastics. (Nylon requires a different platform surface.)

Filament management

An optional filament tube has been included. The filament goes through this tube before going into the extruder. It's optional but can protect the filament. You also need to put your filament roll on something that will allow it to turn- we have an optional lazy susan we sell, or you can find various other arrangements or 3d printable holders if you prefer.

Congratulations- you have finished assembly!

NOTE THAT THIS IS AN EXPERIMENTAL MACHINE, MEANT FOR THOSE WITH EXPERIENCE ASSEMBLING ELECTRONICS, AND HAS EXPOSED POWER TERMINALS. NEVER TOUCH THE POWER SUPPLY TERMINALS WHEN THE MACHINE IS PLUGGED IN. YOU MAY WANT TO 3D PRINT ONE OF THE AVAILABLE COVERS TO LIMIT THE CHANCES OF ANYONE TOUCHING THE TERMINALS.

AS WITH ANY TOOL, THIS SHOULD BE KEPT AWAY FROM CHILDREN AND UNPLUGGED WHEN NOT IN USE.

Now move on to the Flight Check of your printer.